

**TP9100** portables

# User's Guide



[www.taitworld.com](http://www.taitworld.com)



## Chassis engraving will void warranty

**Caution:** Engraving the chassis can significantly reduce its mechanical strength and will void any warranty. If the chassis has been engraved, it must be replaced.

## Copyright and trademarks

All information contained in this manual is the property of Tait Electronics Limited. All rights reserved. This manual may not, in whole or in part, be copied, photocopied, reproduced, translated, stored, or reduced to any electronic medium or machine-readable form, without prior written permission from Tait Electronics Limited.

The word TAIT and the TAIT logo are trademarks of Tait Electronics Limited.

All trade names referenced are the service mark, trademark or registered trademark of the respective manufacturers.

## Disclaimer

There are no warranties extended or granted by this manual. Tait Electronics Limited accepts no responsibility for damage arising from use of the information contained in the manual or of the equipment and software it describes. It is the responsibility of the user to ensure that use of such information, equipment and software complies with the laws, rules and regulations of the applicable jurisdictions.

## Enquiries and comments

If you have any enquiries regarding this manual, or any comments, suggestions and notifications of errors, please contact Technical Support.

## Updates of manual and equipment

In the interests of improving the performance, reliability or servicing of the equipment, Tait Electronics Limited reserves the right to update the equipment or this manual or both without prior notice.

## Intellectual property rights

This product may be protected by one or more patents of Tait Electronics Limited together with their international equivalents, pending patent applications and registered trade marks: NZ508054, NZ508340, NZ508806, NZ508807, NZ509242, NZ509640, NZ509959, NZ510496, NZ511155, NZ511421, NZ516280/519742, NZ519118, NZ519344, NZ520650/537902, NZ521450, NZ524509, NZ524537, NZ524630, NZ530819, NZ534475, NZ534692, NZ535471, NZ536945, NZ537434, NZ534369, NZ522236, NZ524378, AU2003281447, AU2002235062, AU2004216984, CA2439018, EU03784706.8, EU02701829.0, EU04714053.8, GB23865476, GB2386010, GB2413249, GB0516092.4, US60/613748, US60/539617, US10/520827, US10/468740, US5,745,840, US10/520827.

This product may also be made under license under one or more of the following U.S. Patents: 4,590,473 4,636,791 4,716,407 4,972,460 5,146,497 5,148,482 5,164,986 5,185,795 5,185,796 5,271,017 5,377,229 5,502,767.

The IMBE™ voice coding Technology embodied in this product is protected by intellectual property rights including patent rights, copyrights and trade secrets of Digital Voice Systems, Inc. This voice coding Technology is licensed solely for use within this Communications Equipment. The user of this Technology is explicitly prohibited from attempting to decompile, reverse engineer, or disassemble the Object Code, or in any other way convert the Object Code into a human-readable form. Protected by U.S. Patents 5,870,405 5,826,222 5,754,974 5,701,390 5,715,365 5,649,050 5,630,011 5,581,656 5,517,511 5,491,772 5,247,579 5,226,084 and 5,195,166.

## To our European customers



Tait Electronics Limited is an environmentally responsible company which supports waste minimization and material recovery.

The European Union's Waste Electrical and Electronic Equipment Directive requires that this product be disposed of separately from the general waste stream when its service life is over. Please be environmentally responsible and dispose through the original supplier, your local municipal waste "separate collection" service, or contact Tait Electronics Limited.

# For your safety

Before using your radio, please read the following important safety and compliance information.

## Radio frequency exposure information

For your own safety and to ensure you comply with the Federal Communication Commission's (FCC) radio frequency (RF) exposure guidelines, please read the following information before using this radio.

### Using this radio

You should use this radio only for work-related purposes (it is not authorized for any other use) and if you are fully aware of, and can exercise control over, your exposure to RF energy. To prevent exceeding FCC RF exposure limits, you must control the amount and duration of RF that you and other people are exposed to.

It is also important that you:

- Do not remove the RF Exposure label from the radio.
- Ensure this RF exposure information accompanies the radio when it is transferred to other users.
- Do not use the radio if you do not adhere to the guidelines on controlling your exposure to RF.

### Controlling your exposure to RF energy

This radio emits radio frequency (RF) energy or radio waves primarily when calls are made. RF is a form of electromagnetic energy (as is sunlight), and there are recommended levels of maximum RF exposure.

To control your exposure to RF and comply with the maximum exposure limits for occupational/controlled environments, follow these guidelines:

- Do not talk (transmit) on the radio more than the rated transmit duty cycle. This is important because

the radio radiates more energy when it is transmitting than when it is receiving.

- When listening and talking on the radio, hold it upright in front of your face so that it is at least one inch (2.5 cm) away from any part of your face. Keeping the radio at the recommended distance is important because exposure to RF decreases rapidly the further away the antenna is from your body.
- Keep the antenna at least one inch (2.5 cm) from your face at all times.
- If you wear your radio, you must always put it in a carrying accessory that has been specifically approved by Tait for this radio. Using non-approved body-worn accessories may mean you expose yourself to higher levels of RF than recommended by the FCC's occupational/controlled environment RF exposure limits.
- Ensure you only use Tait-approved antennas, batteries, and accessories.

For more information on what RF energy is and how to control your exposure to it, visit the FCC website at <http://www.fcc.gov/oet/rfsafety/rf-faqs.html>.

## Compliance with RF energy exposure standards

This two-way radio complies with these RF energy exposure standards and guidelines:

- United States Federal Communications Commission, Code of Federal Regulations; 47 CFR §§ 1.1307, 1.1310, and 2.1093.
- American National Standards Institute (ANSI) / Institute of Electrical and Electronic Engineers (IEEE) C95.1-1992.
- Institute of Electrical and Electronic Engineers (IEEE) C95.1-1999 Edition.

This radio complies with the IEEE and ICNIRP exposure limits for occupational/controlled RF exposure environments at operating duty factors of up to 50% transmitting (even though the approved batteries for this radio are rated for a 5-5-90 duty factor (5% talk-5% listen-90% standby)).

## **Radio frequency emissions limits in the USA**

Part 15 of the FCC Rules imposes RF emission limits on receivers.

This radio complies with Part 15 of the FCC Rules. Operation is subject to the condition that this device does not cause harmful interference.

## **Unapproved modifications or changes to radio**

The radio is designed to satisfy the applicable compliance regulations. Do not make modifications or changes to the radio that are not expressly approved by Tait Electronics Limited. Failure to do so could invalidate compliance requirements and void the user's authority to operate the radio.

## **USA public safety bands (764–776MHz and 794–806MHz)**

Part 90R of the FCC Title 47 of the Code of Federal Regulations (CFR) deals with the use of frequencies in the 764 to 776MHz and 794 to 806MHz bands.

## **Low-power channels**

This radio complies with §90.531 (b) (3) and §90.531 (b) (4) of 47 CFR. These sections state that only low-power transmission is permitted on the following channels:

- Regional Planning channels, as defined in §90.531 (b) (3).

- Itinerant channels, as defined in §90.531 (b) (4).

## Use of encryption

This radio complies with §90.553 (a) of 47 CFR. This states that:

- Encryption is not permitted on the nationwide Interoperability calling channels. These channels are defined in §90.531 (b) (1) (ii).
- Radios using encryption must have a readily accessible switch or control to allow the radio user to disable encryption.

## Frequency band reserved for distress beacons

Frequency band 406 to 406.1 MHz is reserved for use by distress beacons. Transmissions should not be made within this frequency band.

## Safe radio operation



**Warning:** Switch off the radio:

- at petrol filling stations or near flammable liquids or gases
- in the vicinity of explosive devices and blasting zones.
- before boarding an aircraft. Using your radio while in the air is not permitted.

Using a handheld microphone or a radio while driving a vehicle may violate the laws and legislation that apply in your country or state. Please check the vehicle regulations in your area.

## Interference with electronic devices

Some electronic devices may be prone to malfunction due to the lack of protection from RF energy that is present when your radio is transmitting.



Examples of electronic devices that may be affected by RF energy are:

- vehicular electronic systems such as fuel injection, anti-skid brakes, and cruise control
- medical devices such as hearing aids and pacemakers
- medical equipment in hospitals or health care facilities.

Consult the manufacturer (or its representative) of the equipment to determine whether these electronic circuits will perform normally when the radio is transmitting.



# Menu map

**Note:** The menus shown below may not be available for your radio.

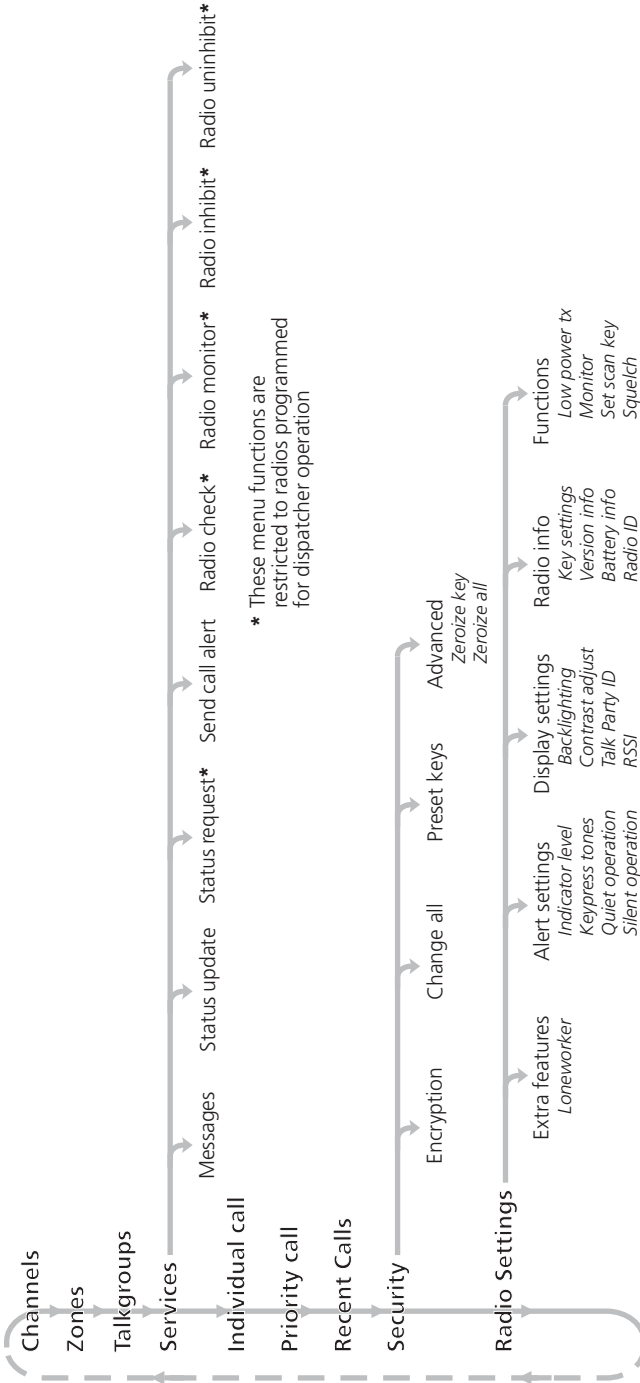

\* These menu functions are restricted to radios programmed for dispatcher operation

# Radio controls

For more information about the radio controls, see [“About your radio” on page 23.](#)

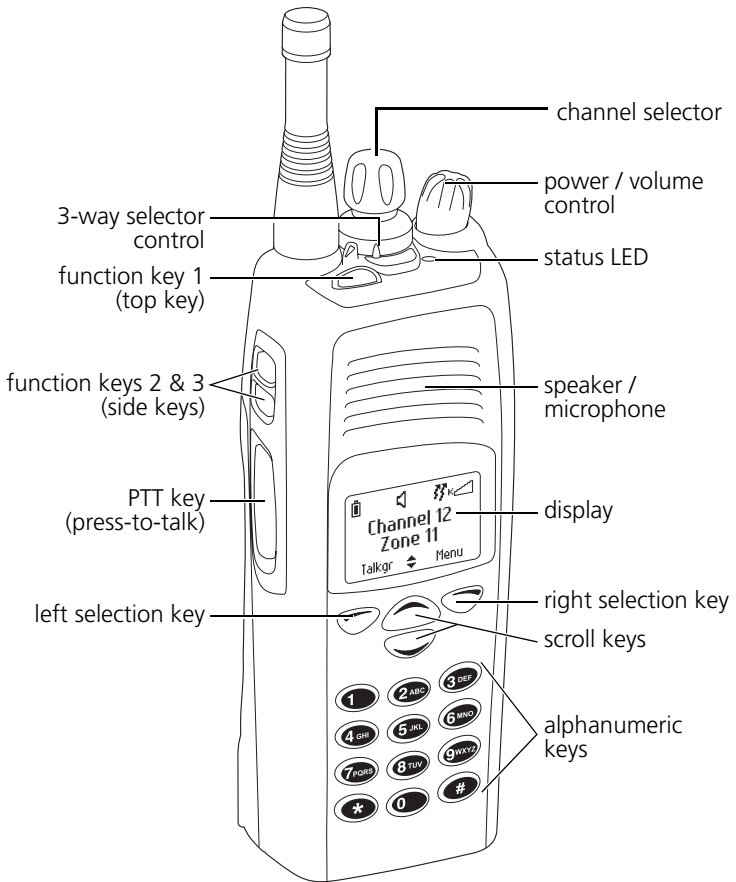

# Contents

- For your safety ..... 5
- Menu map ..... 11
- Radio controls ..... 12
  
- 1 About this guide ..... 17**
  - Safety warnings used in this guide ..... 17
  - Related documentation ..... 17
  
- 2 Before first use of your radio..... 18**
  - Charging the battery before first use ..... 19
  - Attaching a battery ..... 20
  - Attaching the antenna ..... 20
  - Attaching a belt clip ..... 20
  - Fitting a speaker microphone ..... 21
    - Removing the protective cover ..... 21
    - Attaching the accessory connector ..... 21
    - Attaching the antenna to the RF speaker microphone.. 22
  
- 3 About your radio ..... 23**
  - About your digital radio ..... 24
    - Lack of static noise ..... 24
    - Coverage ..... 24
  - Basic operation ..... 25
    - Turning your radio on and off ..... 26
    - Adjusting the volume ..... 26
    - About the channel selector..... 26
    - Using function keys to access frequently used features. 26
    - Three-way selector control ..... 27
    - Emergency key ..... 27
  - Understanding the radio display ..... 28
  - Using the menus to access settings and features ..... 29
    - Selection keys..... 29
    - Scroll keys ..... 29
    - Accessing the Main menu ..... 30
    - Accessing frequently used menus ..... 30
  - Understanding the radio indicators ..... 32
    - Audible tones..... 32
    - Status indicators..... 34

<b>4</b>	<b>Making and receiving calls .....</b>	<b>35</b>
	Making calls .....	36
	Selecting a zone .....	37
	Selecting a channel .....	38
	Understanding talkgroups .....	39
	Making an emergency call.....	40
	Making an individual call.....	40
	Receiving calls .....	41
	Identifying a caller (talking party ID) .....	41
	Communicating directly with other radios .....	42
	Checking your recent calls .....	43
	Checking that the channel is clear (monitor) .....	44
	Turning monitor on and off.....	44
	Call alert paging .....	45
	Checking whether a radio is available .....	46
<b>5</b>	<b>Listening to channel traffic.....</b>	<b>47</b>
	Selecting a voting or scan group .....	48
	Using your radio in different repeater areas .....	50
	Suspending a channel from a voting group .....	50
	Scanning a group of channels .....	51
	Understanding the different types of scanning .....	51
	Making a call while scanning.....	51
	Suspending a channel from a scan group .....	52
	Editing a background scan group .....	52
	Hearing faint and noisy signals .....	55
	Turning squelch override on and off.....	55
<b>6</b>	<b>Sending and receiving messages .....</b>	<b>56</b>
	About messages .....	57
	Sending a message .....	57
	Informing other radio users of your status .....	59
	Requesting a status update .....	60
<b>7</b>	<b>Safeguarding you and your radio .....</b>	<b>61</b>
	Locking and unlocking the keypad .....	62
	Making a radio inoperable .....	63
	Sending a Radio Inhibit request.....	63
	Sending a Radio Uninhibit request.....	64
	Radio monitor .....	65
	Sending a Radio monitor request .....	65

About encryption .....	66
Encrypting your calls.....	66
Making an encrypted call .....	67
Receiving an encrypted call.....	68
Changing your radio's encryption key.....	69
Removing encryption keys from your radio .....	70
About emergency calls .....	71
Making a priority call.....	71
Understanding emergency mode.....	72
About the Lone Worker feature .....	75
About the Man Down feature .....	76
<b>8 Charging and caring for batteries .....</b>	<b>77</b>
Removing the battery .....	78
About your charger .....	79
About battery charging .....	80
Low battery warning .....	80
Optimal charging temperature .....	80
Charging the battery.....	81
Receiving and making calls while charging .....	82
Maintaining battery life and performance .....	83
Battery safety vent.....	83
Storing batteries .....	84
Using nickel-based batteries after storage.....	84
Disposing of batteries .....	84
<b>9 Customizing your radio .....</b>	<b>85</b>
About display and keypad backlighting .....	86
Turning backlighting on or off.....	86
Turning backlighting on momentarily .....	87
Adjusting the display contrast.....	87
Extending battery life on a shift .....	88
Turning low power transmit on or off.....	88
Customizing the audible alert settings .....	89
Changing the volume of all audible tones.....	89
Changing the keypress volume.....	90
Turning off radio controls and keypress tones.....	90
Hearing only channel traffic.....	91

<b>10</b>	<b>Troubleshooting .....</b>	<b>92</b>
	Troubleshooting .....	93
	Error messages.....	93
	When your radio won't turn on.....	94
	Identifying the radio's audible tones.....	94
	Removing a belt clip.....	95
	Checking the version of your radio.....	95
	Troubleshooting your charger .....	96
	General care .....	97
	Cleaning the radio .....	97
<b>11</b>	<b>Glossary.....</b>	<b>98</b>
	<b>Licence agreement.....</b>	<b>100</b>
	<b>Index.....</b>	<b>102</b>



# 1 About this guide

This user's guide provides information about the TP9155 and TP9160 portable radios.

## Safety warnings used in this guide

Within this user's guide, the following warnings are used to alert you to important safety information:



**Warning:** There is a potential risk of death or serious injury.



**Caution:** There is the risk of minor or moderate injury to people.

**Caution:** There is a risk of equipment damage or malfunction.

## Related documentation

The following documentation is also available for your Tait radio, which you can access from the Tait Technical Support website (<http://support.taitworld.com/>):

- *TP9100 Battery Care and Charging Guide*—supplied with each battery and charger. (The same information is in the section “[Charging and caring for batteries](#)” on page 77.)
- *TP9100 Safety and Compliance Information*—supplied with each radio. (The same information is included in this user guide.)

## 2 Before first use of your radio

Once you have unpacked your radio, there are a few tasks you must do before you can use it. The most important of these is to charge your battery for the first time—allow 14 hours for this.

### This section covers:

- [Charging the battery before first use](#)
- [Attaching a battery](#)
- [Attaching the antenna](#)
- [Attaching a belt clip](#)
- [Fitting a speaker microphone](#)

# Charging the battery before first use

Before using your battery for the first time, you **must** charge it for 14 hours (subsequent charges should be complete in two hours or less). This first charge is important because it prepares ('primes') the battery for use. The battery may take two or three shifts (charge/discharge cycles) to reach maximum capacity.

**Note:** Before charging begins, the battery temperature must be close to the room temperature in which the battery is to be charged. Charging is best performed at temperatures between 50 °F (10 °C) and 77 °F (25 °C) and will start only when the temperature of the battery is between 41 °F (5 °C) and 95 °F (35 °C).

- 1 Ensure that the charger is connected to the correct Tait power adaptor (desktop charger) or powered on (multi-charger).
- 2 Put the battery in the charger.

**Note:** For optimal charging results, the radio should be turned off while in the charger.



The red 'Charging' LED glows to indicate that the battery is being charged.

**Note:** If the amber 'Fault' LED lights up, refer to "[General care](#)" on page 97.)

- 3 Leave the battery in the charger for **14 hours**. When the green 'Ready' LED on the charger glows, the battery is ready for use.

You can safely leave the battery in the charger when charging is complete—the charger will not overcharge the battery.

For further information on batteries, see "[Charging and caring for batteries](#)" on page 77.

## Attaching a battery

To attach a battery to your radio:

- 1 Insert the bottom edge of the battery into the two slots at the back of the radio.
- 2 Press down on the top of the battery to snap it into place.

## Attaching the antenna

Before using the radio, screw the antenna clockwise into the antenna connector. The antenna should be screwed sufficiently tight so that it doesn't unscrew easily. This is important as it creates a seal.

## Attaching a belt clip

To attach a belt clip to your radio:

- 1 Slide the belt clip into the two grooves at the top of the battery.

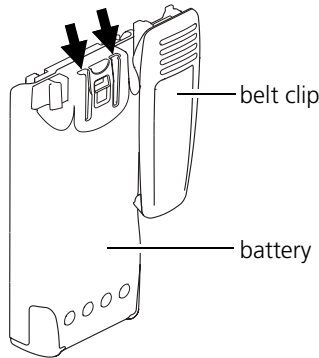

- 2 Push down on the belt clip until it snaps into place.

See also ["Removing a belt clip"](#) on page 95.

# Fitting a speaker microphone

Speaker microphones are attached to the radio via an accessory connector. The standard speaker microphones do not have an antenna connector, whereas the RF speaker microphone has a connector for the radio antenna.

## Removing the protective cover

Before fitting the speaker microphone, you may need to remove the radio's protective cover. This cover is located above the battery on the rear of the radio.

- 1 Insert a coin, or other suitably shaped object, into the slot of the protective cover. Twist the coin clockwise from the locked to unlocked position.
- 2 Remove the cover and store in a safe place.

## Attaching the accessory connector

Once you have removed the protective cover, you can fit the speaker microphone accessory connector to the back of the radio.

- 1 Push and hold the metal clip to release the lever.

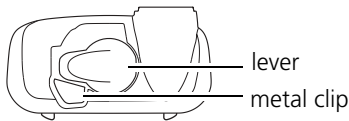

- 2 Rotate the lever clockwise to an upright position.
- 3 Insert the white locking clip into the matching hole at the rear of the radio.

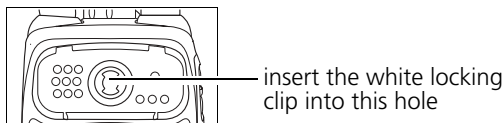

- 4 Rotate the lever counterclockwise until you hear it click.
- 5 Check that the accessory connector is firmly locked into place.

## Attaching the antenna to the RF speaker microphone

Once you have attached the accessory connector to the radio, you can attach the speaker-microphone coax to the radio's antenna connector and then screw the radio's antenna onto the speaker microphone.

- 1 Remove the antenna from the radio.
- 2 Place the brass RF coaxial connector onto the radio's antenna connector.

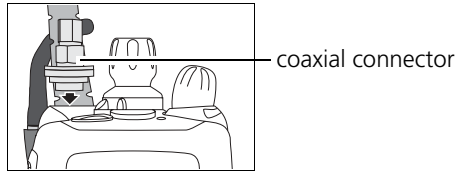

- 3 Tighten the connector with the 5/16 inch spanner, until it sits deep into the radio housing.

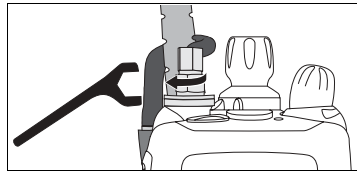

- 4 On the speaker microphone, screw the antenna clockwise into the antenna connector.

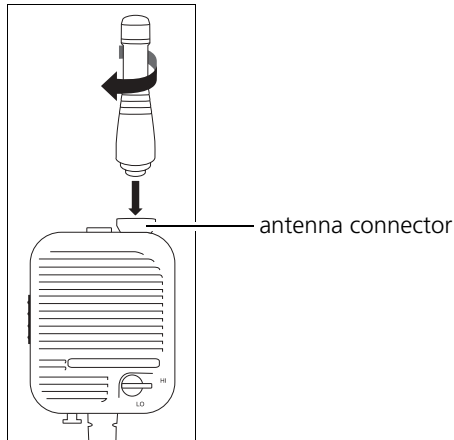

# 3 About your radio

This section describes all the various buttons and keys on your radio.

## This section covers:

- [About your digital radio](#)
- [Basic operation](#)
- [Using function keys to access frequently used features](#)
- [Understanding the radio display](#)
- [Using the menus to access settings and features](#)
- [Understanding the radio indicators](#)

# About your digital radio

Your digital radio may have some channels programmed as either analog or dual mode. Dual mode channels are able to receive both digital and analog calls.

You may notice differences between your radio's analog and digital channels in terms of:

- static noise in low signal areas, and
- radio coverage in marginal reception areas.

## Lack of static noise

On digital channels there is no static noise, even in low signal areas. This lack of static is because your digital radio removes the 'noise' from the call, so that you hear only clear voice.

## Coverage

With analog channels, the background noise in a call gets progressively worse when you are in fringe areas or even slightly outside normal coverage areas. With digital channels, a call remains clear and then drops off quickly at the border of a coverage area. The reason for this is that a digital call is either received or it isn't.



# Basic operation

The radio controls are the PTT key, power/volume control, channel selector, 3-way selector control, scroll keys, selection keys, and function keys. Some keys have functions assigned to both short and long key presses:

- a short key press is less than one second, and
- a long key press is more than one second.

The radio controls and their functions are described in the following sections.

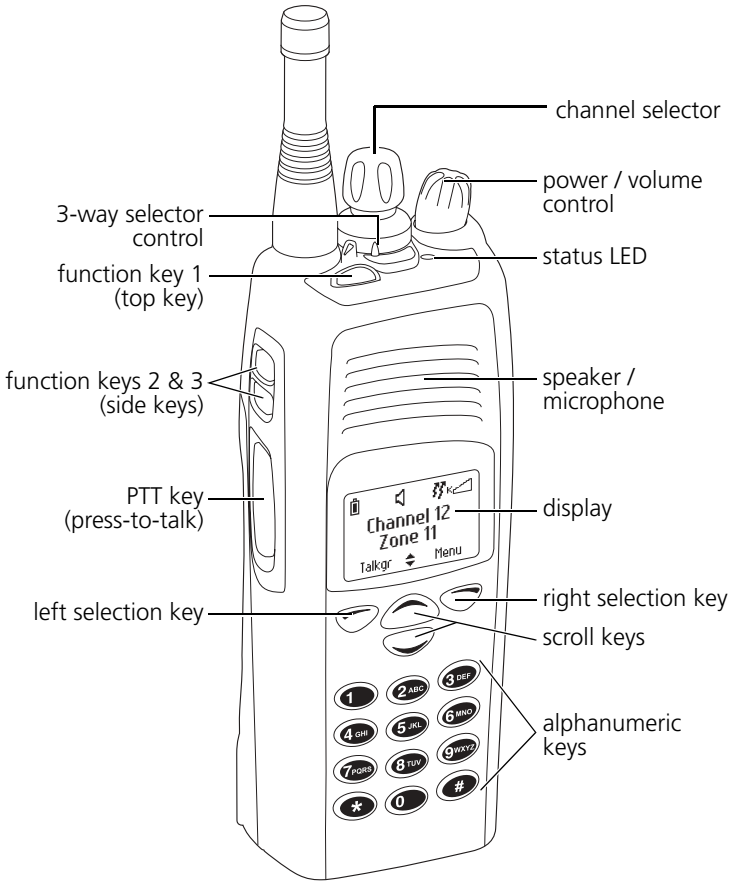

## Turning your radio on and off

Rotate the power/volume control switch clockwise to turn the radio on. Rotate the switch counterclockwise to turn the radio off.

**Note:** Your radio may not turn on if your battery is very low. (See [“Low battery warning”](#) on page 80.)

## Adjusting the volume

With the radio turned on, rotate the power/volume control clockwise to increase the speaker volume and counterclockwise to decrease the volume.

**Note:** The volume control also changes the volume level of the radio’s audible indicators.

## About the channel selector

The channel selector allows you to select and change channels. When first turned on, the radio will go to the channel that was last selected.

See also [“Selecting a channel”](#) on page 38.

## Using function keys to access frequently used features

The function keys provide quick access to some of the features you will use most often. These features are assigned to the function keys when the radio is programmed. Some keys may have a feature associated with both a short key press and a long key press.

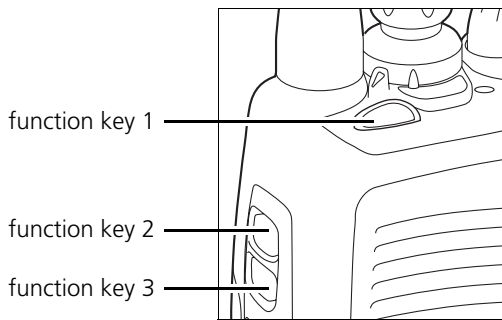

## Viewing your function key settings

To check which functions are assigned to the function keys:

- 1 Press **Menu** and select **Radio settings > Radio info > Key settings**.
- 2 In the menu list, scroll to a function key and press **Select** to view the associated function.

The example shown is for a function key programmed to turn backlighting on and off.



- 3 Press a selection key  or  to return to the menu.

## Three-way selector control

You can use the 3-way selector control to access some of the features you use most often, such as changing zones, locking the radio keypad and activating such features as encryption and repeater talkaround.

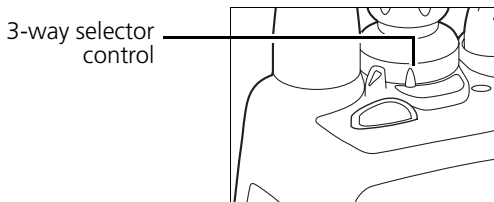

## Emergency key















You can activate emergency mode by pressing the function key 1, if your radio is programmed in this way.

See also [“About emergency calls” on page 71](#).

# Understanding the radio display

The messages and symbols you see on your radio display depend on the mode in which your radio is operating and the way it is programmed.

These are the various symbols you may see on your radio display:

Symbol	Meaning
	Signal strength indicator: the more bars, the stronger the signal being received by your radio
	Transmit: your radio is transmitting
	Low-power transmit: indicates that low power mode is turned on
	Repeater talkaround: your radio is operating in repeater talkaround mode
	Zone: this letter represents the zone in which your radio is operating, where <b>A</b> is zone 1 and <b>Z</b> is zone 26 (in the example shown, <b>K</b> represents zone 11)
	Scanning: your radio is monitoring a group of channels for activity
	Monitor or squelch override: monitor or squelch override is active
	Silent operation: your radio's audible tones have been turned off
	Encryption: your radio's transmissions are encrypted
	Scrolling: you can use the scroll keys  or  to move through a list
	Battery indicator: shows how much charge is available in the battery
	Battery in charger: appears when you place a radio (with a TP9100 battery attached) in the charger

# Using the menus to access settings and features

You can access settings and features for your radio using the menu.

The selection and scroll keys enable you to make selections and move around the menus.

## Selection keys

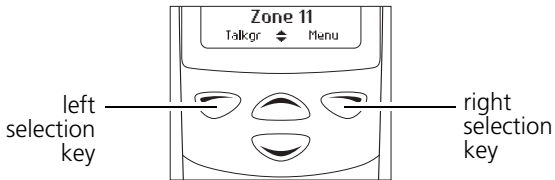

There are two selection keys beneath the display screen. How these keys work depend on the word that appears above them on the screen.

## Scroll keys

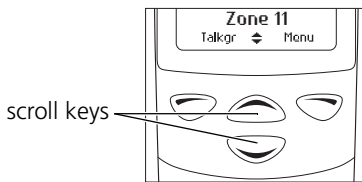

The up and down scroll keys allow you to:

- access the Quick Access menu
- scroll up and down through a list
- display the previous or next part of a message that is too long to be displayed on the screen.

## Accessing the Main menu

- 1 To access the Main menu, press the right selection key whenever **Menu** appears above it.

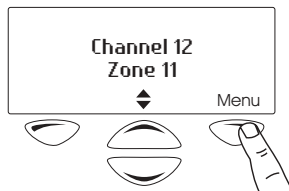

- 2 Use the scroll keys to move through the menu list.

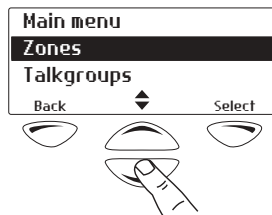

- 3 When the menu you want is highlighted, press **Select** to enter the menu you have chosen.





**Tip:** To quickly exit the menu system, press and hold the left selection key when the word **Cancel** or **Back** appears above it.



## Accessing frequently used menus

Depending on how your radio is programmed, you may have two different 'quick access' menus. One quick access menu is displayed when you press a scroll key, and the other when you press the left selection key. These give you easy access to the menus you use most often.

### Using the scroll key Quick Access menu

There are two ways to use this Quick Access menu:

- Press a scroll key  or , to begin scrolling through a list of zones or channels.
- Press a scroll key  or , and the Quick Access menu appears.

In this example, the Talkgroups menu is the Quick Access menu. Press a scroll key  or  to go directly to the Talkgroups menu.

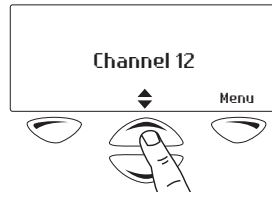

The Talkgroups menu, with a list of your available talkgroups, is now displayed:

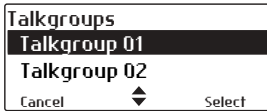

## Using the left selection key Quick Access menu

The text above the left selection key corresponds to the Quick Access menu, for example, Talkgroups.

To use this Quick Access menu:

- Press your left selection key , and the associated menu appears.

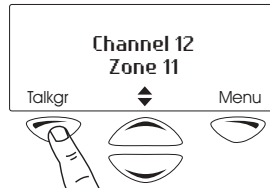

# Understanding the radio indicators

The status LED indicator and the radio’s audible tones— together with the radio display—all combine to give you information about the state of your radio.

The most common way the indicators work is described in the following sections.

## Audible tones

The radio uses audible tones to alert you to its status:

- Radio controls and keypress tones—the tones and beeps you hear when you press your radio’s keys or use the controls. (You can turn these tones off—see [“Turning off radio controls and keypress tones” on page 90.](#))
- Incoming call tone—when the radio is receiving a call.
- Warning tones—when there is an error, or the battery is low, for example.

**Note:** If quiet or silent mode is turned on, you will not hear any alert tones. See [“Customizing the audible alert settings” on page 89.](#)

Some of the more common audible tones are described below:

Tone	Meaning
One short beep	<ul style="list-style-type: none"><li>■ Valid keypress: the action you have attempted is permitted, or</li><li>■ Function activated: a function has been turned on (using either the Main menu or a function key)</li></ul>



Tone	Meaning
One long, low-pitched beep	<ul style="list-style-type: none"> <li>■ Invalid keypress: the action you have attempted is not permitted, or</li> <li>■ Transmission inhibited: you have attempted to transmit, but for some reason you cannot make a call at this time</li> </ul>
One short, low-pitched beep	Function deactivated: a function has been turned off (using either the Main menu or a function key)
Two short beeps	Radio turned on: the radio is powered on and ready to use

## Status indicators

**Note:** The way these indicators behave may be affected by the way your radio is programmed.

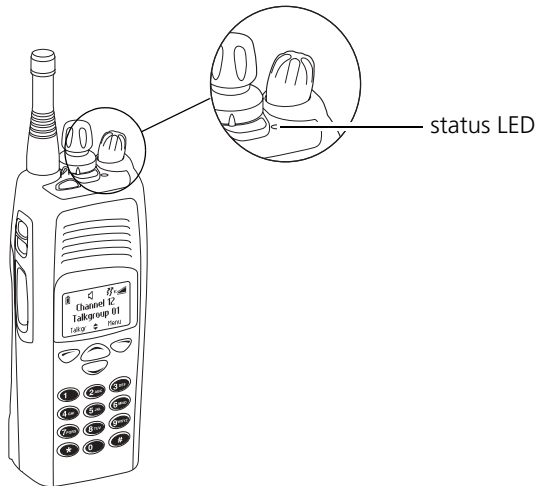

Color	Meaning
Red (transmit)	Glowing: your radio is transmitting
Green (receive)	Glowing: the current channel is busy Flashing: you have received a call

# 4 Making and receiving calls

This section describes how to make and receive calls.

## This section covers:

- Making calls
- Receiving calls
- Communicating directly with other radios
- Checking your recent calls
- Checking that the channel is clear (monitor)
- Call alert paging
- Checking whether a radio is available

# Making calls

- 1 Select the required zone (see “Selecting a zone” on page 37).
- 2 Select the required channel (“Selecting a channel” on page 38).
- 3 Select the required talkgroup (see “Making a talkgroup call” on page 39) or individual radio unit ID (see “Making an individual call” on page 40).
- 4 Hold the radio so that the microphone is about one inch (2.5 cm) from your mouth and press the PTT key to transmit.

**Note:** If the channel is busy, you may not be able to transmit. Wait until the green status LED has stopped glowing, and then try again.

- 5 Speak clearly into the microphone and release the PTT key when you have finished talking.

While you are transmitting the LED glows red and the transmit symbol appears in the display:

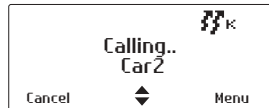

## Limiting call time (transmit timer)

Your radio may limit the amount of time you can talk (transmit) continuously. This is known as the ‘transmit timer’ or ‘time-out timer’ and allows other radio users to make calls on that channel.

The message **Transmit Timeout Imminent** appears in the display.

Finish your conversation as soon as possible and release the PTT. For a short time, your radio may prevent you from making a call.

# Selecting a zone

A zone is a collection of channels. Zones are a way of grouping channels, for example, by public safety agency type (fire, police, ambulance, etc.) or by geographical region (Dallas, Houston, etc.).

- 1 Press **Menu** and select **Zones**.
- 2 Scroll to the zone you want.
- 3 Press **Select**.

Your radio may indicate the zone in which it is currently operating in the following ways:

- the name of the zone appears below the channel name in the default radio display, or
- the zone symbol appears as a letter in the top right corner of the display.

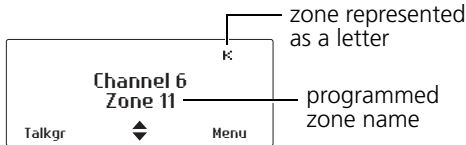

## Other ways of selecting a zone

You may also be able to use the following controls to select a zone:

- 3-way selector (see [“Three-way selector control” on page 27](#))
- left selection key (see [“Using the left selection key Quick Access menu” on page 31](#)), or
- scroll keys (see [“Using the scroll key Quick Access menu” on page 30](#)).

## Selecting a channel

It is important to distinguish between channels and talkgroups. A channel is frequency-related, whereas a talkgroup is a group of radio users. Talkgroups are only available for digital channels.

For an explanation of talkgroups, see [“Understanding talkgroups” on page 39](#).

### Using the channel selector

For channels 1 to 16, rotate the channel selector to the channel you want. For all other channels, use the Main menu to select a channel.

### Using the Main menu

- 1 Press **Menu** and select **Channels**.
- 2 Scroll to the channel you want and press **Select**.

### Other ways of selecting a channel

You may also be able to use the following controls to select a channel:

- function key (see [“Using function keys to access frequently used features” on page 26](#))
- left selection key (see [“Using the left selection key Quick Access menu” on page 31](#))
- scroll keys (see [“Using the scroll key Quick Access menu” on page 30](#)).

# Understanding talkgroups

**Note:** This feature is available for digital channels only.

Talkgroups are a collection of people (radio unit IDs) with whom you want to have private conversations as a group.

For example, a state's public safety agencies could have the following talkgroups:

- Local talkgroups—used by a specific agency to communicate within their own local agency. It may even be made up of a county of public safety officers.
- Regional talkgroups—used by large state agencies that have regional divisions.
- Statewide talkgroups—used by an agency to communicate with a public safety member in another region. Statewide talkgroups, as their name suggests, enable public safety agencies to communicate with each other from one end of the state to the other.
- Special event talkgroups—may be used to manage emergencies encompassing a large area, or even events such as visits by heads of state.

## Making a talkgroup call

- 1 Press **Menu** and select **Talkgroups**.

(Depending on how your radio is programmed, you may be able to use a Quick Access menu to go to the Talkgroup menu.)

- 2 Scroll through the list of talkgroups to the one you want and press **Select**.

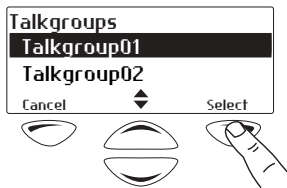

- 3 Press the PTT key to make a call to the currently selected talkgroup.

## Making an emergency call

For information about making and ending emergency calls together with a explanation of how your radio behaves in emergency mode, see [“About emergency calls” on page 71](#) and [“Understanding emergency mode” on page 72](#).

## Making an individual call

**Note:** This feature is available for digital channels only.

To make a call to one person rather than a group of people:

- 1 Press **Menu** and select **Individual call**. (The person to whom you last made an individual call is highlighted.)

(Depending on how your radio is programmed, you may be able to press a function key or use your Quick Access menu to select individual calls.)

- 2 Scroll to the person you want to call and press the PTT key to make the call immediately.
- 3 Alternatively, scroll to the person you want to call and press **Select**.

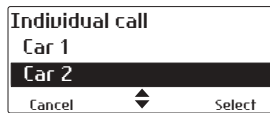

The message **Call...?** briefly appears in the screen:

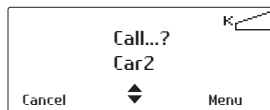

- 4 Press the PTT key to make the call.



# Receiving calls

When a call is received with valid signaling, the radio unmutes and you can hear the call.

## Identifying a caller (talking party ID)

**Note:** This feature is available for digital channels only.

You can use Talking Party ID to identify the radio user calling you. (This feature is usually turned on when the radio is programmed.)

- talkgroup call: the name of the talkgroup is displayed:



- individual call: the name of the radio name from your call list is displayed (if there is no associated name, only the radio unit ID is shown):

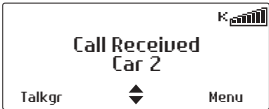

## Turning talking party ID off and on

- 1 Press **Menu** and select **Radio settings > Display settings > Talk party ID**.
- 2 Scroll to either **On** (or **Off**) and press **Select**. (The current setting is highlighted).

The message **Talking party ID activated** (or **Talking party ID deactivated**) appears in the display:

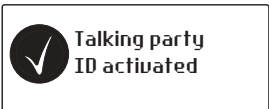

# Communicating directly with other radios

You can bypass the radio repeater and communicate directly with another radio using the Radio Talkaround feature. You can do this when you are out of range of the repeater, or if the repeater is busy.

While repeater talkaround is active, all calls are made on your current channel's receive frequency.

## Turning repeater talkaround on and off

You can turn repeater talkaround on and off using a function key, if your radio is programmed in this way.

- Press the function key to turn repeater talkaround on.

The message **Repeater talkaround activated** (or **Repeater talkaround deactivated**) appears and the repeater talkaround symbol  appears in the display.

Repeater talkaround remains on until you press the function key again.

# Checking your recent calls

**Note:** This feature is available for digital channels only and applies to individual calls and call alert pages only.

Your radio may be able to store a list of the last 20 calls. These calls may be calls that you have received or calls that you have made.

## Using your recent calls list to make a call

- 1 Press **Menu** and select **Recent calls**. (Depending on how your radio is programmed, you may be able to press a function key or use your Quick Access menu to select recent calls.)

The most recent call is displayed at the top of the list. If you have not participated in any calls since your radio was switched on, the message **No items in list** appears in the display.

- 2 Scroll through the list of recent calls until the call you want appears, and then press **Call**.

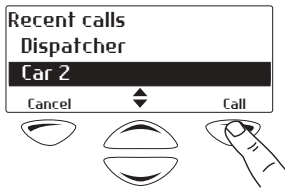

The message **Call...?** briefly appears in the screen.

Press the PTT key to make the call.

- 3 Alternatively, scroll through the list of recent calls until the call you want appears.

Press the PTT key to make the call immediately.

# Checking that the channel is clear (monitor)

Monitor allows you to override some or all of the radio's mutes, allowing you to hear if there is any traffic (including talkgroup and individual calls) on a channel.

For analog channels, this is so that you can check that the channel is clear before you make a call.

## Turning monitor on and off

- 1 Press **Menu** and select **Radio settings > Functions > Monitor**.

(Depending on how your radio is programmed, you may be able to press a function key to toggle monitor on and off.)

- 2 Scroll to **On** (or **Off**) and press **Select**.

The monitor symbol  appears in the display and remains on while monitor is active.

# Call alert paging

**Note:** This feature is available for digital channels only and applies to individual calls only.

You can let another radio user know that you want to talk to them by sending them a call alert page. When the other radio user receives the call alert page, they can call you back when it is convenient.

## Sending a call alert page

- 1 Press **Menu** and select **Services** > **Send call alert**.
- 2 Scroll to the radio you wish to page from the call list and press **Send to**.

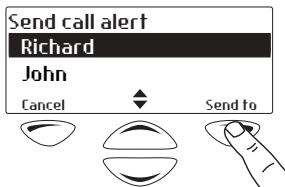

A message appears in the display:



The LED glows red and a message may be displayed to advise you whether the call alert has been sent successfully or not.

If an acknowledgement is not received from the recipient's radio, you may have the option of either cancelling or resending the call alert page.

## Answering a call alert page

If you receive a call alert page from another radio user, the message **Page Rx'd from ...** briefly appears in the display.

Select **Call** to return the page or **OK** to delete it. If you miss the call alert page, the identity of the caller may be saved in your recent calls list.

# Checking whether a radio is available

**Note:** This feature is available for digital channels only and for radios configured for dispatcher operation.

If you want to find out whether a particular radio is available on the system, you can use the Radio Check feature. This sends a radio-check message to the radio unit you have specified.

- 1 Press **Menu** and select **Services > Radio check**.
- 2 Scroll to the radio you wish to check from the call list.
- 3 Press **Send to**.

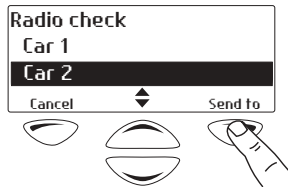

The LED glows red and a message showing the destination appears in the display:

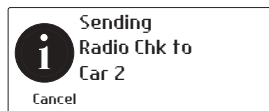

If the radio is available on the system, an acknowledgement message is displayed:



# 5 Listening to channel traffic

This section describes using your radio in different repeater areas, scanning a group of channels for activity, and using the squelch override function to hear faint and noisy signals on a channel.

## This section covers:

- [Selecting a voting or scan group](#)
- [Using your radio in different repeater areas](#)
- [Scanning a group of channels](#)
- [Hearing faint and noisy signals](#)

# Selecting a voting or scan group

A group is a collection of channels that are grouped together for either voting or scanning. Voting or scanning groups can be made up of channels from different zones. You may be able to select groups either by using a function key, the channel selector or by using the Main menu.

The following sections explain how your radio operates once a group has been selected:

- voting groups: “Using your radio in different repeater areas” on page 50, and
- scan groups: “Scanning a group of channels” on page 51.

## Using the channel selector

You can use the channel selector to select a preset voting or scan group, if your radio is programmed in this way.

- Rotate the channel selector to the group you want.

The programmed group name may now appear in the display along with the scanning symbol  :

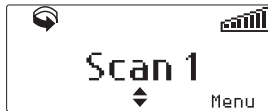

## Using a function key

To use a function key to select a preset voting or scan group:

- Press the function key to select and activate a preset voting or scan group.



The programmed group name may now appear in the display along with the scanning symbol  :



## Using the Main menu

To select a voting or scan group using the Main menu:

**Note:** This method is not available for background scan.

- 1 Press **Menu** and select **Channels**.
- 2 Scroll to the group you want and press **Done**.

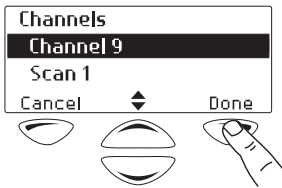

The scanning symbol  appears in the display:



# Using your radio in different repeater areas

Your radio may have a group of channels programmed as a voting group. The channels in the voting group all carry the same traffic, but from different repeaters. As your radio moves in and out of different repeater coverage areas, the best communication channel is automatically selected for you to use.

This channel is known as the 'home' channel, and may be the channel you make and receive calls on. While voting is active, the scanning symbol  appears in the display.

## Suspending a channel from a voting group

You may be able to use the function key programmed for 'nuisance delete' to temporarily remove one of the channels from the voting group.

To remove a channel from a voting group:

- 1 Wait until the radio has stopped on the channel that you want to remove from the voting group.
- 2 Press the function key programmed for nuisance delete.

If the channel has been successfully been removed, the message **Channel deleted from group** briefly appears in the display:



The channel remains removed from the voting group until you either select another voting group or the radio is turned off and then on again.

**Note:** The function key programmed to activate a voting group may be programmed so that a short key press activates voting and a long key press activates nuisance delete.

# Scanning a group of channels

The scanning feature is used to monitor a pre-programmed group of channels for activity. When a busy channel is detected in a group, the radio stops on ('captures') that channel, and you can now hear the call. Scanning resumes when the channel is no longer busy.

**Note:** 'Priority' channels may be specified when the radio is programmed. These are channels that you want the radio to check for activity more often than other 'non-priority' channels. Priority channels are scanned periodically when a non-priority channel is busy.

## Understanding the different types of scanning

The two types of scanning that may be available on your radio are *standard* scanning and *background* scanning. Background scan can only be activated using a function key programmed for background scan. When you activate background scan, the currently selected channel automatically becomes a member of the scan group.

## Making a call while scanning

If you want to make a call while your radio is scanning:

- 1 Lift the microphone off the microphone clip.
- 2 Press the PTT key to transmit.

If background scan is active, your radio will now call the currently selected channel.

If standard scan is active and there has been no recent activity on the channel, then the channel that is called depends on the way your radio has been programmed. The possible options are:

- your radio calls a predetermined channel e.g. your dispatcher

- your radio calls the channel where activity was last detected
  - your radio calls the last free channel.
- 3 When the called party responds, proceed with your conversation.

## Suspending a channel from a scan group

If the radio is continuously stopping on an undesired channel (for example, if there is too much activity or even interference) while scanning, you may be able to temporarily remove this channel from the scan group. To remove a channel from a scan group:

- 1 Wait until the radio has stopped on the channel that you want to remove from the scan group.
- 2 Press the function key programmed for nuisance delete.

If the channel has been successfully been removed, the message **Channel deleted from group** appears in the display:

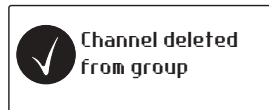

The channel remains removed from the scan group until you either select another scan group or the radio is turned off and then on again.

**Note:** The function key programmed to activate a scan group may be programmed so that a short key press activates scanning and a long key press activates nuisance delete.

## Editing a background scan group

You may be able to permanently change the membership of your background scan group by using the function key programmed for nuisance delete.

When background scan is active, you can scroll through the channel list to see which channel is a member of your background scan group. When the channel is a group member, the scanning symbol  includes a tick.

**Note:** The function key programmed to activate your background scan group may be programmed so that a short key press activates background scan and a long key press activates nuisance delete.

## Adding a channel to your background scan group

- 1 Press the function key that activates background scan.

The scanning symbol  appears in the display:



- 2 Scroll through the list of channels until the channel that you want to add appears.

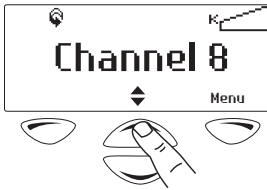

- 3 Press the nuisance delete key and this channel is now added to your background scan group.

The message **Channel added** appears in the display and the scanning symbol  now includes a tick:



## Removing a channel from your background scan group

- 1 Press the function key that activates background scan.

The scanning symbol  appears in the display:



- 2 Scroll through the list of channels until the channel that you want to delete appears.

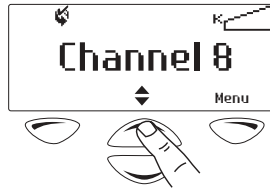

- 3 Press the nuisance delete key and this channel is now deleted from your background scan group.

The message **Channel deleted** appears in the display and the scanning symbol  no longer includes a tick.



# Hearing faint and noisy signals

**Note:** This feature is only applicable to analog channels.

Usually the radio's squelch mute (known as 'squelch') prevents you from hearing faint or noisy calls on a channel. Without squelch, the radio's speaker would 'chatter' in low signal strength areas.

On occasions when you want to hear everything that is being said on a channel, even if it is hard to understand, you can use the Squelch Override feature to force the mute open.

## Turning squelch override on and off

- 1 Press **Menu** and select **Radio settings > Functions > Squelch override**.

(Depending on how your radio is programmed, you may be able to press a function key to turn squelch override on and off.)

- 2 Scroll to **On** (or **Off**) and press **Select**.

The message **Squelch override activated** (or **Squelch override deactivated**) appears in the display.

# 6 Sending and receiving messages

This section describes sending messages as well as responding to requests for status information.

## This section covers:

- [About messages](#)
- [Informing other radio users of your status](#)
- [Requesting a status update](#)



# About messages

**Note:** This feature is available for digital channels only.

You may be able to send short messages to another radio user. These messages are defined at programming time and are also known as 'pre-programmed messages'.

The person to whom you are sending the message must have the same message programmed into their radio in order to read and display your message.

## Sending a message

You may be able to send your message to a predetermined person or talkgroup, or to a person of your choice.

### Sending a message to a predetermined person or talkgroup

- 1 Press **Menu** and select **Services > Messages**.  
(Depending on how your radio is programmed, you may be able to press a function key or use your Quick Access menu to select messages.)
- 2 Select the message you want from the message list and press **Select**.

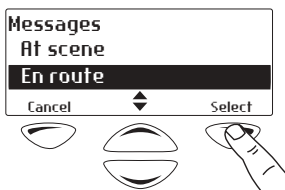

A message showing the destination appears in the display:

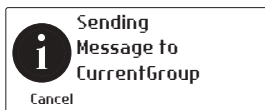

The LED glows red and a message may be displayed to advise you whether the message has been sent successfully or not.

## Sending a message to a person of your choice

- 1 Press **Menu** and select **Services > Messages**.  
(Depending on how your radio is programmed, you may be able to press a function key or use your Quick Access menu to select messages.)
- 2 Select the message you want from the message list and press **Select**.

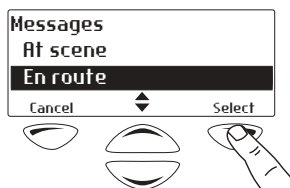

- 3 Select the message recipient from the list and press **Send to**.

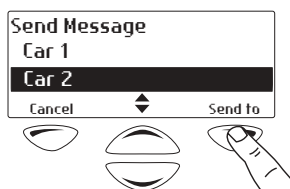

A message showing the destination briefly appears in the display.

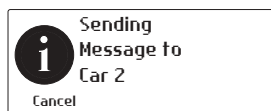

The LED glows red and a message may be displayed to advise you whether the message has been sent successfully or not.

# Informing other radio users of your status

**Note:** This feature is available for digital channels only.

You can inform other radio users of your current status by sending them a status update, for example, 'At scene'. You may be able to send the status update to a predetermined person or talkgroup, or to a person of your choice.

When you send a status message, you are also *setting* your status, which the dispatcher may be able to check by 'interrogating' your radio. You can change your status at any time by selecting another status message and sending it. See "[Requesting a status update](#)" on page 60.

To send a status update:

- 1 Press **Menu** and select **Services > Status update**. (Depending on how your radio is programmed, you may be able to press a function key or use your Quick Access menu to select status update.)
- 2 Select the status message you want from the message list and press **Send to** or **Select**.

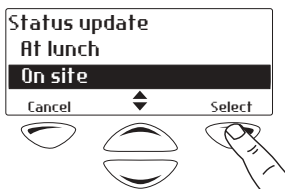

A message showing the destination appears in the display:

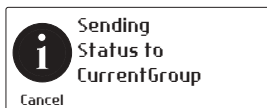

The LED glows red and a message may be displayed to advise you whether the status update has been sent successfully or not.

# Requesting a status update

**Note:** This feature is available for digital channels only and for radios configured for dispatcher operation.

You can find out what another radio user is currently doing by asking them to send you a status update.

To send a status request:

- 1 Press **Menu** and select **Services > Status request**.
- 2 Select the status request recipient from the list and press **Send to** key.

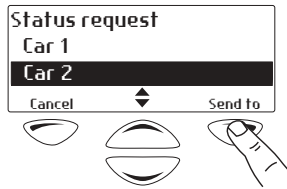

A message showing the destination appears in the display:

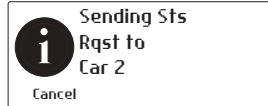

The LED glows red and a message may be displayed to advise you whether the message has been sent successfully or not.

# 7 Safeguarding you and your radio

This section describes how to prevent unauthorized use of your radio, how to make your communications completely private and how to get help when you need it most.

## This section covers:

- [Locking and unlocking the keypad](#)
- [Making a radio inoperable](#)
- [Radio monitor](#)
- [About encryption](#)
- [About emergency calls](#)
- [Making a priority call](#)
- [Understanding emergency mode](#)
- [About the Lone Worker feature](#)
- [About the Man Down feature](#)

# Locking and unlocking the keypad

You can lock the keypad to prevent accidental calls caused by the keypad being bumped.

When the keypad is locked, you can still answer calls as normal by pressing the PTT.

- 1 To lock the keypad, press and hold the right selection key  for about one second.

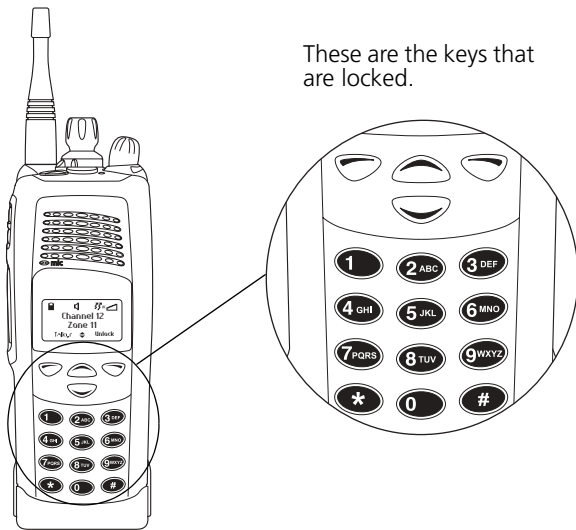

The message **Keypad locked** briefly appears in the display, and **Unlock** appears above the right selection key, in place of **Menu**.

When any of the locked keys are pressed, the message **Keypad lock active** appears.

- 2 To unlock the keypad, press and hold the right selection key  for about one second.

# Making a radio inoperable

**Note:** This feature is available for digital channels only and for radios configured for dispatcher operation.

If you want to make another radio on the system inoperable, you can use the Radio Inhibit feature. This feature is also known as 'stun'.

To the user of the inhibited radio, it appears as though the radio has turned off. The radio remains inoperable even if it is turned off and then on again.

The radio cannot return to operation until it receives an 'uninhibit' request. This is also known as 'revive'.

## Sending a Radio Inhibit request

- 1 Press **Menu** and select **Services > Radio inhibit**.
- 2 Scroll to the radio you wish to make inoperable.
- 3 Press **Send to**.

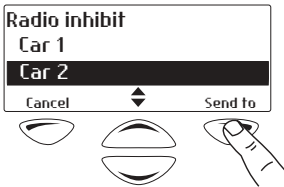

The LED glows red and a message appears in the display:

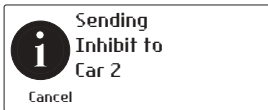

If the radio has been successfully immobilized, an acknowledgement message is displayed:



## Sending a Radio Uninhibit request

- 1 Press **Menu** and select **Services > Radio uninhibit**.
- 2 Scroll to the radio you wish to make operable.
- 3 Press **Send to**.

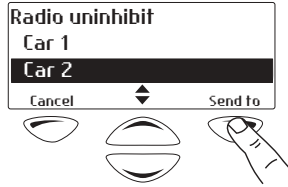

The LED glows red and a message appears in the display:

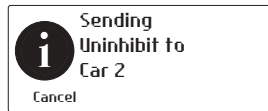

If the radio has been successfully returned to operation, an acknowledgement message is displayed:

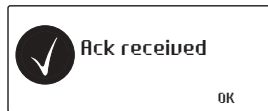



# Radio monitor

**Note:** This feature is available for digital channels only and for radios configured for dispatcher operation.

The Radio Monitor feature can be used when you are concerned about the safety of a radio user on your system. When you send a radio-monitor request to a radio, it calls you back without giving any indication that it is making a call. You can hear any activity near the radio for up to 20 seconds.

## Sending a Radio monitor request

- 1 Press **Menu** and select **Services > Radio monitor**.
- 2 Scroll to the radio you wish to monitor.
- 3 Press **Send to**.

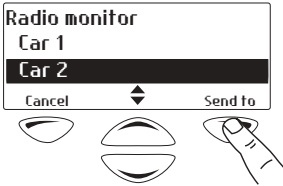

The LED glows red and a message appears in the display:

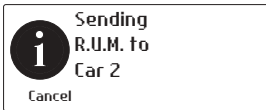

If the other radio has received your request, it will now call you, so that you can monitor activity near the radio.

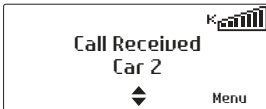

# About encryption

**Note:** This feature is available for digital and dual-mode channels only.

To make communications with other users on your system completely private, your radio may be able to encrypt outgoing calls, using a confidential encryption key. The radio receiving your call must have the same encryption key installed before it can hear your encrypted call.

## Encrypting your calls

Your radio may be able to turn encryption on and off. While encryption is on, your outgoing calls are encrypted on channels programmed for encryption, and the encryption symbol  remains in the display.

**Note:** This setting only affects outgoing calls. Incoming calls will still be decoded by your radio so long as the key required to decode the call is stored in your radio.

To turn encryption on or off:

- 1 Press **Menu** and select **Security > Encryption**.  
(Depending on how your radio is programmed, you may be able to press a function key to turn encryption on and off.)
- 2 Scroll to **On** (or **Off**) and press **Select**.

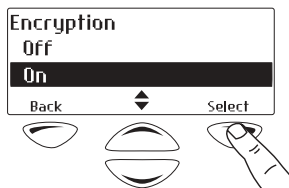

The message **Encryption activated** (or **Encryption deactivated**) appears in the display.

## Using the 3-way selector

To turn encryption on and off using the 3-way selector:

- 1 Rotate the 3-way selector to either position A or B to turn encryption on.

The message **Encryption activated** briefly appears in the display.

- 2 Rotate the 3-way selector to position C to turn encryption off.

The message **Encryption deactivated** briefly appears in the display.

## Making an encrypted call

- 1 Select the channel or group you wish to call.
- 2 Check that encryption is on (the encryption symbol  is showing in the display).
- 3 Check that the channel is free (green LED is off).
- 4 Press and hold the PTT key to transmit.

The name of the encryption key that your radio is using for the transmission may briefly appear in the display:



While you are transmitting, the LED glows red and the transmit symbol appears in the display.

## Receiving an encrypted call

When you receive an encrypted call, your radio unmutes and you can hear clear speech, so long as the key required to decode the call is stored in your radio.

The name of the encryption key used to encrypt the incoming call may briefly appear in the display, below the name of the caller:



If the key required to decode the call is not stored in your radio, then your radio remains muted.

**Note:** Your radio may also remain muted if the currently selected channel has 'proper key detect' programmed.

### Proper Key Detect feature

Your radio may be programmed with 'proper key detect'. This means that you can only hear an encrypted call if the key used to encrypt the incoming call matches the key used to encrypt your outgoing calls on that channel.

**Note:** Encryption does not need to be turned 'on' for the radio to unmute.

For example, you are encrypting your outgoing calls using encryption **key 7**. Although **key 1** and **key 2** are also stored in your radio, your radio has been programmed so that it will only unmute for incoming calls encrypted using **key 7**.

## Changing your radio's encryption key

You may be able to use the Change All menu to change the encryption key that encrypts your outgoing calls. You can then use the Preset Keys menu to change the encryption keys back to the default encryption key for each channel.

**Note:** Once you change the encryption key, it may also automatically update the encryption keys used to encrypt calls on other channels.

### Changing your transmit encryption key

- 1 Press **Menu** and select **Security > Change all**.
- 2 Scroll to the key you want and press **Select**.

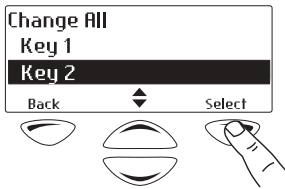

The message **Global Key Selected** briefly appears in the display.

### Changing your transmit encryption key back to the default setting

- 1 Press **Menu** and select **Security > Preset keys**.

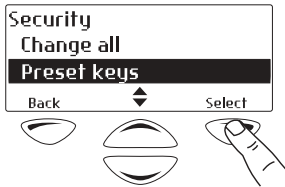

The message **Select Preset Keys?** appears in the display.

- 2 Select **OK** and the message **Preset Keys selected** briefly appears in the display.

# Removing encryption keys from your radio

It may be possible for you to delete encryption keys from your radio.

**Note:** When emergency mode is activated, or when your radio is immobilized ('inhibited'), your encryption keys may be automatically deleted from your radio.

## Deleting an encryption key

- 1 Press **Menu** and select **Security** > **Advanced** > **Zeroize key**.
- 2 Scroll to the key you want and press **Select**.

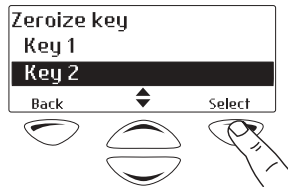

The message **Single Key Zeroized** briefly appears in the display.

## Deleting all encryption keys

- 1 Press **Menu** and select **Security** > **Advanced** > **Zeroize all**.

The message **Zeroize All Keys?** appears in the display.

- 2 Press OK and the message **All Keys Zeroized** briefly appears in the display and the encryption symbol  no longer appears.

# About emergency calls

In an emergency you can summon help by sending an emergency call. There are two types of emergency calls:

Call type	Explanation
Priority call	(Digital channels only.) An emergency alert is automatically sent to the current talkgroup. Calls made when the priority call feature is turned on are flagged as 'emergency' calls.
Emergency call	Typically for life and death situations. When an emergency call is initiated, the radio enters 'emergency mode'. For further information see " <a href="#">Understanding emergency mode</a> " on page 72.

## Making a priority call

**Note:** This feature is available for digital channels only.

When you turn the Priority Call feature on, the radio automatically sends an emergency alert (message) to the current talkgroup.

Any calls you make while the Priority Call feature is turned on are flagged as 'emergency' calls.

To turn the priority call feature on and off:

- 1 Press **Menu** and select **Priority call**.

(Depending on how your radio is programmed, you may be able to press a function key to turn priority call on and off.)

- 2 Scroll to **On** (or **Off**) and press **Select**.

## Understanding emergency mode

When you press the emergency key your radio enters 'emergency mode', if your radio is programmed in this way.

When the radio enters emergency mode, it will automatically send alerts together with your radio unit ID to the dispatcher. These alerts are usually sent on a designated emergency channel.

**Note:** The way your radio behaves in emergency mode depends on how your radio is programmed.

For further information on what your radio may do in emergency mode, see ["What happens during an emergency call?"](#) on page 72.

### Stealth and non-stealth emergency modes

Your radio is programmed to operate in one of these ways:

- **Stealth:** you often work in situations where you do not want an assailant to know that you have activated emergency mode. For this reason, the radio is silent and the display remains unchanged—there is no indication that the radio has entered emergency mode.
- **Non-stealth:** you often work in situations where you want audible and visual confirmation that you have activated emergency mode (for example, at an accident scene).

### What happens during an emergency call?

The exact way your radio behaves when it enters emergency mode depends on how your radio is programmed. The main phases for both stealth and non-stealth emergency modes are summarized below. The length of each phase is determined when the radio is programmed.



When the emergency key is pressed:

①

The radio continually sends alerts to the dispatcher until a response is received. Details of your location may also be sent (if this feature is available for your radio).



②

The radio alternately transmits and receives so the dispatcher can hear what is happening in the vicinity of your radio.

(Non-stealth emergencies end once this phase is complete or when you end emergency mode.)



③

**Stealth emergencies only:** The radio is inactive, but it can receive special 'messages' from the dispatcher so that he or she can hear what is happening in the vicinity of the radio.

(Stealth emergencies end once this phase is complete or when you end emergency mode.)

See also "[Stealth and non-stealth emergency modes](#)" on page 72.

## Activating emergency mode

You can activate emergency mode using the emergency function key.

- 1 Press the function or emergency key to activate emergency mode.

'Emergency mode' appears in the display:

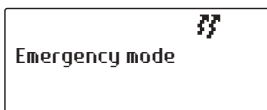

One or more emergency calls are sent to your dispatcher or another predetermined radio user. During emergency mode, the radio will behave as described in [“What happens during an emergency call?”](#) on page 72.

- 2 Turn the radio off and on again to end emergency mode. The radio returns to normal operation.

# About the Lone Worker feature

Lone Worker is a safety feature for people who work alone. The radio requests a response from you at regular predetermined intervals. If you are unable to respond, the radio either enters emergency mode or sends a status update to a predetermined person or talkgroup.

An audible warning is given one or two minutes before the radio enters emergency mode or sends the status update, to warn you and to prevent false activation.

## Responding to a Lone Worker alarm

If you hear a beep to indicate that the radio is expecting a response from you to acknowledge that you are safe:

- Press the programmed function key.

Otherwise the radio will activate emergency mode or send a status update.

# About the Man Down feature

The Man Down feature activates when the radio is tilted more than 60 degrees (for example, the radio user has been attacked and is lying on the ground).

If the radio remains in this position for one or two minutes, it will beep to warn the radio user. If you do not respond after a further beep, the radio either enters emergency mode or sends a status update to a predetermined person or talkgroup.

## **Preventing false activation of emergency mode**

If you hear a beep to warn you that the radio has sensed it is not upright, and it is *not* an emergency situation, you can prevent the radio from falsely activating emergency mode by either:

- restoring the radio to an upright position (by standing up, for example), or
- pressing the programmed function key.

# 8 Charging and caring for batteries

This section describes how to charge your Tait radio battery as well as care for it to ensure maximum performance and prolonged battery life.

**Note:** The instructions in this section apply to both the desktop charger and the multi-charger.

## This section covers:

- [Removing the battery](#)
- [About your charger](#)
- [About battery charging](#)
- [Maintaining battery life and performance](#)
- [Storing batteries](#)
- [Disposing of batteries](#)

# Removing the battery

See also [“Attaching a battery”](#) on page 20.

To remove the battery from the radio so that the battery can be charged or replaced:

- 1 Squeeze and quickly release both battery catches to release the catch mechanism. (Don't push down on the battery; allow the catch mechanism to release the battery from the radio)

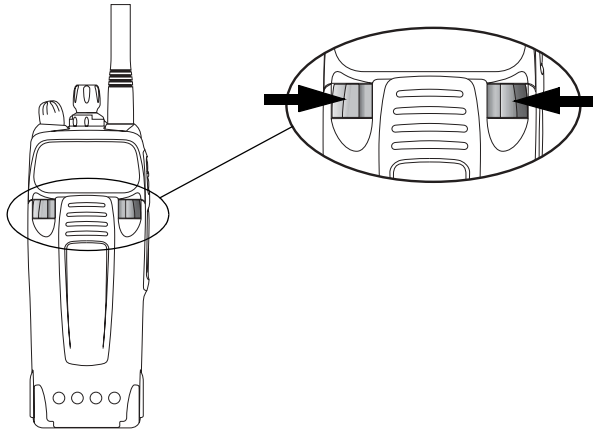

- 2 Remove the battery from the radio.

# About your charger

There are two types of charger available for your Tait radio battery:

- Desktop charger—small enough to fit on your desk, it charges one battery at a time.
- Multi-charger—charges up to six batteries. It can be mounted on a desk, on a wall, or in an equipment rack.



**Note:** The charging instructions in this section apply to both the desktop charger and the multi-charger.

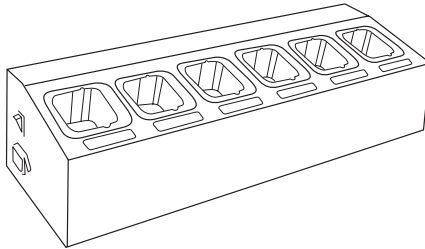



When the charger is first connected to a suitable power supply, all three LEDs light up briefly.

# About battery charging

See also “Charging the battery before first use” on page 19.

## Low battery warning

When the battery is almost empty, your radio warns you in the following ways:

- The battery indicator on the radio display looks empty. 
- The status LED slowly flashes  red.
- A high-pitched beep sounds.

You should recharge or replace the battery as soon as possible.

When the battery is completely empty, the message **Battery is flat** appears on the display. The radio emits a long, low-pitched beep and then stops operating.

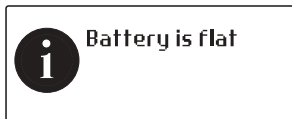

Turn off the radio immediately. You will reduce the battery's service life if you allow the battery to fully discharge each time you use it.

## Optimal charging temperature

To achieve the best results when charging your battery:

- Before charging begins, the battery temperature must be close to the room temperature in which the battery is to be charged.
- Charging is best performed between 50°F (10°C) and 77°F (25°C) and starts only when the battery is between 41°F (5°C) and 95°F (35°C).

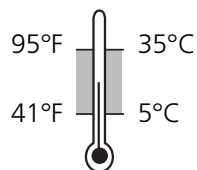



# Charging the battery

**Important:** If you are charging the battery for the first time, follow the instructions on [page 19](#).

- 1 Desktop charger—ensure that the charger is connected to the correct Tait power adaptor.  
Multi-charger—ensure the charger is powered on.
- 2 Put the battery in the charger.

**Note:** For optimal results, the radio should be turned off while in the charger.

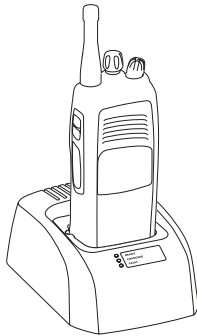

Turn your radio *off* while charging, for best results.

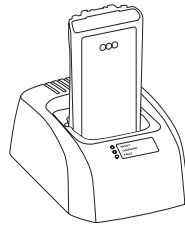

If a radio is attached and turned on, the 'battery in charger'  symbol appears in the radio display.

The red 'Charging' LED glows to indicate that the battery is charging. For a battery that is almost completely discharged, allow two hours.

**Note:** If the amber 'Fault' LED lights up, refer to "[General care](#)" on [page 97](#).

- 3 The green 'Ready' LED on the charger glows when the battery is fully charged. Remove it when you are ready—the charger will not overcharge the battery.

**Note:** If the radio was turned on while being charged, the battery indicator may not be accurate when the radio is initially removed from the charger. After a few seconds, the battery indicator is updated to display the amount of charge available in the battery.

## Receiving and making calls while charging

You can receive or make a call while the radio is in the charger. If you do remove the radio from the charger to answer a call, the call will not be disrupted.

**Note:** Removing the radio from the charger to make or receive a call ends the charging process. Charging safely recommences when the radio is reinserted into the charger.

# Maintaining battery life and performance

With proper care and maintenance you will maintain the performance and life of the battery. It is recommended that you:

- Use only Tait chargers.
- Avoid exposing batteries to high temperatures (above 122°F (50°C)) or extremely cold temperatures for long periods of time (-4°F (-20°C) for NiMH, and -22°F (-30°C) for NiCd).
- Charge batteries at room temperature (between 50°F (10°C) and 77°F (25°C)).
- Allow your nickel-based battery to fully discharge every so often—NiCd batteries once a month and NiMH batteries once every 3 months. To do this, leave your radio turned on and ignore the 'battery low' warnings. When the radio turns off, the battery is fully discharged.
- Store batteries properly when not in use. See ["Storing batteries"](#) on page 84.

## Battery safety vent



**Warning:** Do not cover the battery safety vent (shown below).

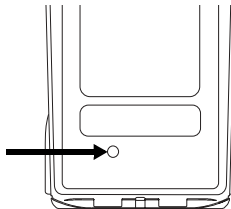

## Storing batteries

When not in use for a month or more, batteries should be stored correctly to prolong their life:

- Remove the battery from the radio before storage.
- Store the battery (in either a charged or discharged state) in a cool dry place.

## Using nickel-based batteries after storage

Batteries that have been stored for any length of time must be charged before being used. See [“Charging the battery” on page 81](#).

When first using nickel-based batteries that have been in storage for three months or more, you may notice that they do not last an entire shift. This is normal. If stored properly, the battery’s optimal capacity should be restored after two or three shifts (charge/discharge cycles).

## Disposing of batteries

Batteries should be disposed of properly. NiCd (nickel cadmium) batteries contain cadmium which, if disposed of in landfills, is very hazardous to the environment.



Please contact your radio provider for information on recycling programs in your area.

# 9 Customizing your radio

This section describes the ways in which you can customize your radio.

## **This section covers:**

- [About display and keypad backlighting](#)
- [Extending battery life on a shift](#)
- [Customizing the audible alert settings](#)

# About display and keypad backlighting

Whenever the keypad is pressed, the 3-way or channel selector controls are turned, or a call is received, the keypad and display light up automatically to make it easy to read in poor light conditions.

Backlighting usually remains on for a few seconds, unless further radio activity is detected. The period of time that the backlighting remains on once no further radio activity is detected is determined by the backlighting timer. The duration of this timer is set when the radio is programmed.

The radio's display can also be made darker or lighter to suit your working conditions. See ["Adjusting the display contrast"](#) on page 87.

## Turning backlighting on or off

- 1 Press **Menu** and select **Radio settings > Display settings > Backlighting**.

(Depending on how your radio is programmed, you may be able to press a function key to turn backlighting on or off.)

- 2 Scroll to either **On** or **Off** and press **Select**. (The current setting is highlighted.)

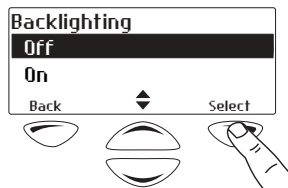

The message **Backlighting activated** (or **deactivated**) appears in the display:





## Turning backlighting on momentarily

You can turn backlighting on momentarily using a function key, if your radio is programmed in this way. Backlighting remains on for a few seconds and then turns off.

## Adjusting the display contrast

To change the contrast of your radio display to suit the lighting conditions that you are working in:

- 1 Press **Menu**, and select **Radio settings > Display settings > Contrast adjust**.
- 2 Use the scroll keys  or  to adjust the display contrast to the level you want.

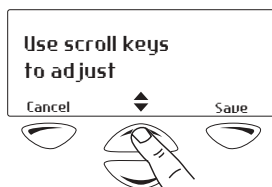

- 3 Press **Save** to save this setting.

# Extending battery life on a shift

You can reduce the power consumption of your radio (and thereby extend the life of the battery during a shift) in the following ways:

- Transmit at low power (if your radio is not already configured to do this).
- Ensure that backlighting automatically turns off when no radio activity is detected (see [“About display and keypad backlighting”](#) on page 86).

## Turning low power transmit on or off

If you are using your radio in conditions where signal strength is high, you can extend the shift life of your battery by transmitting at low power.

When low power transmit is turned on,  appears in the display and calls are made at low power rather than at the programmed power setting.

To turn low power transmit on or off for all channels:

- 1 Press **Menu** and select **Radio settings > Functions > Low power transmit**.

(Depending on how your radio is programmed, you may be able to press a function key to turn low power transmit on or off.)

- 2 Scroll to **On** (or **Off**) and press **Select**. (The current setting is highlighted.)

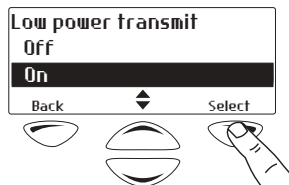

The message **Low power transmit activated** (or **deactivated**) appears in the display.



# Customizing the audible alert settings

The radio uses audible tones to alert you to its status:

- Radio controls and keypress tones—the beeps you hear when you press your radio’s keys or use the controls. (You can turn these tones off—see [“Turning off radio controls and keypress tones”](#) on page 90.)
- Incoming call tone—when the radio is receiving a call.
- Warning tones—when there is an error, or the battery is low, for example.

## Changing the volume of all audible tones

You can set the volume of all the audible sounds that the radio makes to indicate what is happening.

To change the volume of the audible tones between high or low:

- 1 Press **Menu** and select **Radio settings > Alert settings > Indicator level**.

(Depending on how your radio is programmed, you may be able to press a function key to change the volume of the audible tones between high or low.)

- 2 Scroll to **High** or **Low** and press **Select**. (The current setting is highlighted.)

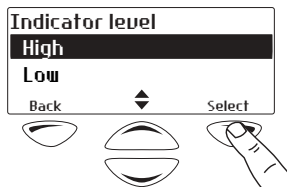

## Changing the keypress volume

Whenever you press a key, you will hear a beep to indicate whether or not what you are trying to do is allowed:

- Allowed: a short, medium-pitched beep.
- Not allowed: a long, low-pitched beep.

To change the volume of the keypress beeps between high, low, and off:

- 1 Press **Menu** and select **Radio settings > Alert settings > Keypress tones**.

(Depending on how your radio is programmed, you may be able to use a function key to switch the volume of the keypress beeps between high, low, and off.)

- 2 Scroll to **High**, **Low**, or **Off** and press **Select**. (The current setting is highlighted.)

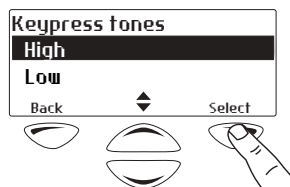

## Turning off radio controls and keypress tones

You can turn off all the tones and beeps you hear when you press the keys or use the radio controls. This is known as 'quiet operation'. You will still hear incoming call and warning tones.

To turn quiet operation on or off:

- 1 Press **Menu** and select **Radio settings > Alert settings > Quiet operation**.

(Depending on how your radio is programmed, you may be able to press a function key to turn backlighting on or off.)

- 2 Scroll to **On** or **Off** and press **Select**. (The current setting is highlighted.)

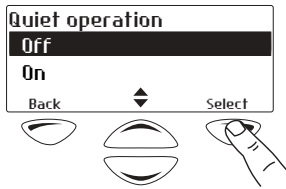

The message **Quiet operation activated** (or **deactivated**) appears in the display.

## Hearing only channel traffic

You can turn off all the audible tones that the radio makes so that the only sound you will hear from the speaker is channel traffic. This is known as 'silent operation'.

When silent operation is turned on  appears in the display.

To turn silent operation on or off:

- 1 Press **Menu**, and select **Radio settings** > **Alert settings** > **Silent operation**.

(Depending on how your radio is programmed, you may be able to press a function key to turn silent operation on or off.)

- 2 Scroll to **On** or **Off** and press **Select**. (The current setting is highlighted.)

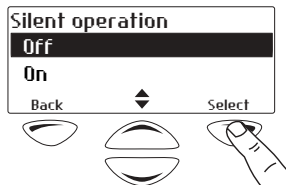

The message **Silent operation activated** (or **deactivated**) appears in the display.

# 10 Troubleshooting

This section describes troubleshooting procedures and basic maintenance.

## **This section covers:**

- [Troubleshooting](#)
- [Error messages](#)
- [When your radio won't turn on](#)
- [Removing a belt clip](#)
- [Checking the version of your radio](#)
- [Troubleshooting your charger](#)
- [General care](#)
- [Cleaning the radio](#)



# Troubleshooting

If you are experiencing difficulty operating your radio, you may find the following sections helpful. Consult your radio provider for assistance, if necessary.

## Error messages

If an error message appears in the radio display, refer to the table below.

For any error messages not shown in the table below, it is recommended that you make a note of the error code (the letter 'E' followed by a four-digit number, for example, E0001) and consult your radio provider.

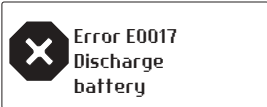
Error message	What you must do
 Error E0001 Unknown Reboot radio	Turn the radio off and back on again.
 Error E0009 High Temp Stop Tx	The radio is very hot—turn it off and allow it to cool down.
 Error E0017 Discharge battery	The battery has not been fully discharged for some time and the battery capacity information is now out of date. The battery indicator in the radio display may not accurately indicate the remaining charge.  Fully discharge the battery (for instructions see <a href="#">“Maintaining battery life and performance” on page 83</a> ) and then charge it.

## When your radio won't turn on

If the red LED on the radio does not light up when the radio is turned on, it is probable that power is not reaching the radio. Check the following:

- Is the battery firmly attached to the radio?
- Is the battery sufficiently charged?
- Is the battery charger working properly?

If all appears to be in order, but your radio still fails to operate properly, contact your radio provider for further assistance.

## Identifying the radio's audible tones

The radio's audible tones can help you identify a potential problem:

Audible tone	Meaning
One short, high-pitched beep	The radio has been made inoperable ('stunned' or 'inhibited') by your service provider.
Two short beeps	The radio has been made operable ('revived' or 'uninhibited') by your service provider.
Two low-pitched beeps	The radio's temperature is high. (The radio will continue to operate.)
Two high-pitched beeps	The radio's temperature is in the very high range and all calls will now be at low power. If the radio's temperature rises above this range, calls will be inhibited.  Turn off the radio and allow it to cool down.

## Removing a belt clip

The belt clip has been designed to prevent accidental removal, but you can take it off, if required.

To remove a belt clip from a battery:

- 1 Insert a flat screwdriver blade or similar flat object under the lip of the release lock (that is, between it and the metal slider).

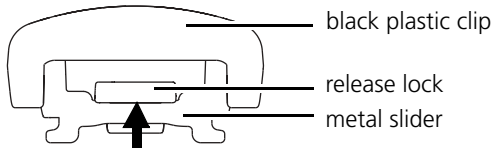

- 2 Lift the release lock up (away from the metal slider) and hold it in position.

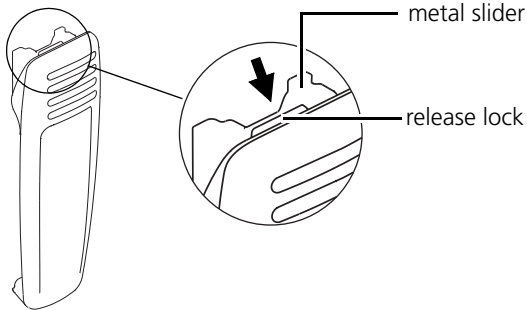

- 3 Slide the belt clip out.

## Checking the version of your radio

Your radio provider may ask you for the hardware and firmware version of your radio, for troubleshooting purposes.

### Using the Main menu

- 1 Press **Menu** and select **Radio info > Version info**.
- 2 Scroll to the version information you want to view and press **Select**.



## Using the PTT key

- Hold down the PTT key and turn on the radio.

The firmware and hardware versions, and your radio's frequency band may be briefly displayed.

## Troubleshooting your charger

The table below describes what to do if the amber 'Fault' light on the battery charger is either flashing or glowing.

Charger Fault LED	Meaning	Possible reason(s) and solution
Flashing 	Fault	<ul style="list-style-type: none"><li>■ The battery is not compatible with the charger—use only Tait chargers and batteries.</li><li>■ There is insufficient voltage to the charger—check you are using the correct power adaptor.</li><li>■ The battery may be deeply discharged (less than 3V)—disconnect the battery from the radio and charge the battery.</li><li>■ The battery may be faulty—consult your radio provider for advice.</li></ul>
Glowing 	Charging suspended	The battery is either too hot or too cold. Charging will begin when the temperature of the battery is between 41°F (5°C) and 95°F (35°C).



## General care

Your radio requires no regular maintenance other than ensuring that the battery has sufficient charge and that no damage has occurred to the antenna or the battery.

To prevent permanent damage to the radio case, do not allow the radio to come into contact with detergents, alcohol, aerosol sprays, or petroleum-based products.

For battery care, see [“Maintaining battery life and performance” on page 83](#).

## Cleaning the radio

If you need to clean the radio case, use a cloth dampened with clean water. Do not immerse the radio in fluids.

# 11 Glossary

## A

**APCO** The Association of Public Safety Communications Officials. The APCO Project 25 standards committee (<http://www.apcointl.org>) defined a digital radio standard. The standard is often referred to as 'APCO' or 'P25'.

## C

**channel** A channel is a pair of frequencies used to transmit and receive radio signals.

## F

**FCC** Federal Communications Commission, an independent United States government agency that regulates interstate and international radio communications.

## L

**LED** Light Emitting Diode, a device that is able to emit light.

## M

**mute** A mute controls the circumstances under which a received signal is passed to the radio's speaker. For example, when a signal is received by the radio, the mute may remain 'closed' if the signal is not strong enough, does not have valid signaling or is encrypted.

## P

**P25** Project 25. The Association of Public Safety Communications Officials (APCO) established Project 25 (P25). This project was led by United States Federal, state, and local government representatives to develop standards for interoperable digital radios and systems to meet the needs of public safety users. See <http://www.project25.org> for further information.

## R

**repeater** A repeater is a relaying site, usually situated above a city or town. The repeater extends the range of radio communications by receiving and re-transmitting signals received from radios.

**RF** Radio Frequency, the part of the electromagnetic spectrum that is suitable for radio transmissions. The frequency of the RF signal is described in terms of the number of cycles per second or Hertz (Hz).

**RSSI** Received Signal Strength Indicator, a symbol or number that shows the strength of a received signal.

## V

**valid signal** A valid signal is a signal that the radio responds to by unmuting the receiver. A signal may be valid, for example, when it is stronger than a minimum level or has special signaling that matches the signaling programmed for the receiving radio.

# Licence agreement

This legal document is an Agreement between you (the "Licensee") and Tait Electronics Limited ("Tait"). By using any of the Software or Firmware items prior-installed in the related Tait product, included on CD or downloaded from the Tait website, (hereinafter referred to as "the Software or Firmware") you agree to be bound by the terms of this Agreement. If you do not agree to the terms of this Agreement, do not install and use any of the Software or Firmware. If you install and use any of the Software or Firmware that will be deemed to be acceptance of the terms of this licence agreement.

The terms of this Agreement shall apply subject only to any express written terms of agreement to the contrary between Tait and the Licensee.

## LICENCE

TAIT GRANTS TO YOU AS LICENSEE THE NON-EXCLUSIVE RIGHT TO USE THE SOFTWARE OR FIRMWARE ON A SINGLE MACHINE PROVIDED YOU MAY ONLY:

1. COPY THE SOFTWARE OR FIRMWARE INTO ANY MACHINE READABLE OR PRINTED FORM FOR BACKUP PURPOSES IN SUPPORT OF YOUR USE OF THE PROGRAM ON THE SINGLE MACHINE (CERTAIN PROGRAMS, HOWEVER, MAY INCLUDE MECHANISMS TO LIMIT OR INHIBIT COPYING, THEY ARE MARKED "COPY PROTECTED"), PROVIDED THE COPYRIGHT NOTICE MUST BE REPRODUCED AND INCLUDED ON ANY SUCH COPY OF THE SOFTWARE OR FIRMWARE;  
AND / OR
2. MERGE IT INTO ANOTHER PROGRAM FOR YOUR USE ON THE SINGLE MACHINE (ANY PORTION OF ANY SOFTWARE OR FIRMWARE MERGED INTO ANOTHER PROGRAM WILL CONTINUE TO BE SUBJECT TO THE TERMS AND CONDITIONS OF THIS AGREEMENT).

THE LICENSEE MAY NOT DUPLICATE, MODIFY, REVERSE COMPILE OR REVERSE ASSEMBLE ANY SOFTWARE OR FIRMWARE IN WHOLE OR PART.

## IMPORTANT NOTICE

THE SOFTWARE OR FIRMWARE MAY CONTAIN OPEN SOURCE SOFTWARE COMPONENTS ("OPEN SOURCE COMPONENTS"). OPEN SOURCE COMPONENTS ARE EXCLUDED FROM THE TERMS OF THIS AGREEMENT EXCEPT AS EXPRESSLY STATED IN THIS AGREEMENT AND ARE COVERED BY THE TERMS OF THEIR RESPECTIVE LICENCES WHICH MAY EXCLUDE OR LIMIT ANY WARRANTY FROM OR LIABILITY OF THE DEVELOPERS AND/OR COPYRIGHT HOLDERS OF THE OPEN SOURCE COMPONENT FOR THE PERFORMANCE OF THOSE OPEN SOURCE COMPONENTS. YOU AGREE TO BE BOUND BY THE TERMS AND CONDITIONS OF EACH SUCH LICENCE. FOR MORE INFORMATION SEE:  
<http://support.taitworld.com/go/opensource>

## TITLE TO SOFTWARE

THIS AGREEMENT DOES NOT CONSTITUTE A CONTRACT OF SALE IN RELATION TO THE SOFTWARE OR FIRMWARE SUPPLIED TO THE LICENSEE. NOT WITHSTANDING THE LICENSEE MAY OWN THE MAGNETIC OR OTHER PHYSICAL MEDIA ON WHICH THE SOFTWARE OR FIRMWARE WAS ORIGINALLY SUPPLIED, OR HAS SUBSEQUENTLY BEEN RECORDED OR FIXED, IT IS A FUNDAMENTAL TERM OF THIS AGREEMENT THAT AT ALL TIMES TITLE AND OWNERSHIP OF THE SOFTWARE OR FIRMWARE, WHETHER ON THE ORIGINAL MEDIA OR OTHERWISE, SHALL REMAIN VESTED IN TAIT OR THIRD PARTIES WHO HAVE GRANTED LICENCES TO TAIT.

## TERM AND TERMINATION

THIS LICENCE SHALL BE EFFECTIVE UNTIL TERMINATED IN ACCORDANCE WITH THE PROVISIONS OF THIS AGREEMENT. THE LICENSEE MAY TERMINATE THIS LICENCE AT ANY TIME BY DESTROYING ALL COPIES OF THE SOFTWARE OR FIRMWARE AND ASSOCIATED WRITTEN MATERIALS. THIS LICENCE WILL BE TERMINATED AUTOMATICALLY AND WITHOUT NOTICE FROM TAIT IN THE EVENT THAT THE LICENSEE FAILS TO COMPLY WITH ANY TERM

OR CONDITION OF THIS AGREEMENT. THE LICENSEE AGREES TO DESTROY ALL COPIES OF THE SOFTWARE OR FIRMWARE AND ASSOCIATED WRITTEN MATERIALS IN THE EVENT OF SUCH TERMINATION.

### **LIMITED WARRANTY**

THE SOFTWARE OR FIRMWARE (INCLUDING OPEN SOURCE COMPONENTS) IS SUPPLIED BY TAIT AND ACCEPTED BY THE LICENSEE "AS IS" WITHOUT WARRANTY OF ANY KIND EITHER EXPRESSED OR IMPLIED, INCLUDING BUT NOT BEING LIMITED TO ANY IMPLIED WARRANTIES AS TO MERCHANTABILITY OR FITNESS FOR ANY PARTICULAR PURPOSE. THE LICENSEE ACKNOWLEDGES THAT THE SOFTWARE OR FIRMWARE (INCLUDING OPEN SOURCE COMPONENTS) IS USED BY IT IN BUSINESS AND ACCORDINGLY TO THE MAXIMUM EXTENT PERMITTED BY LAW NO TERMS OR WARRANTIES WHICH ARE IMPLIED BY LEGISLATION SHALL APPLY TO THIS AGREEMENT. TAIT DOES NOT WARRANT THAT THE FUNCTIONS CONTAINED IN THE SOFTWARE OR FIRMWARE (INCLUDING OPEN SOURCE COMPONENTS) WILL MEET THE LICENSEE'S REQUIREMENTS OR THAT THE OPERATION OF THE SOFTWARE OR FIRMWARE (INCLUDING OPEN SOURCE COMPONENTS) WILL BE UNINTERRUPTED OR ERROR FREE.

### **EXCLUSION OF LIABILITY**

IN NO CIRCUMSTANCES SHALL TAIT BE UNDER ANY LIABILITY TO THE LICENSEE, OR ANY OTHER PERSON WHATSOEVER, WHETHER IN TORT (INCLUDING NEGLIGENCE), CONTRACT (EXCEPT AS EXPRESSLY PROVIDED IN THIS AGREEMENT), EQUITY, UNDER ANY STATUTE, OR OTHERWISE AT LAW FOR ANY LOSSES OR DAMAGES WHETHER GENERAL, SPECIAL, EXEMPLARY, PUNITIVE, DIRECT, INDIRECT OR CONSEQUENTIAL ARISING OUT OF OR IN CONNECTION WITH ANY USE OR INABILITY OF USING THE SOFTWARE OR FIRMWARE (INCLUDING OPEN SOURCE COMPONENTS). THE LICENSEE'S SOLE REMEDY AGAINST TAIT WILL BE LIMITED TO BREACH OF CONTRACT AND TAIT'S SOLE AND TOTAL LIABILITY FOR ANY SUCH CLAIM SHALL BE LIMITED AT THE OPTION OF TAIT TO THE REPAIR OR REPLACEMENT OF THE SOFTWARE OR FIRMWARE OR THE REFUND OF THE PURCHASE PRICE OF THE SOFTWARE OR FIRMWARE.

### **GENERAL**

THE LICENSEE CONFIRMS THAT IT SHALL COMPLY WITH THE PROVISIONS OF LAW IN RELATION TO THE SOFTWARE OR FIRMWARE.

### **LAW AND JURISDICTION**

THIS AGREEMENT SHALL BE SUBJECT TO AND CONSTRUED IN ACCORDANCE WITH NEW ZEALAND LAW AND DISPUTES BETWEEN THE PARTIES CONCERNING THE PROVISIONS HEREOF SHALL BE DETERMINED BY THE NEW ZEALAND COURTS OF LAW. PROVIDED HOWEVER TAIT MAY AT ITS ELECTION BRING PROCEEDINGS FOR BREACH OF THE TERMS HEREOF OR FOR THE ENFORCEMENT OF ANY JUDGEMENT IN RELATION TO A BREACH OF THE TERMS HEREOF IN ANY JURISDICTION TAIT CONSIDERS FIT FOR THE PURPOSE OF ENSURING COMPLIANCE WITH THE TERMS HEREOF OR OBTAINING RELIEF FOR BREACH OF THE TERMS HEREOF.

### **NO DEALINGS**

THE LICENSEE MAY NOT SUBLICENSE, ASSIGN OR TRANSFER THE LICENCE OR THE PROGRAM EXCEPT AS EXPRESSLY PROVIDED IN THIS AGREEMENT. ANY ATTEMPT OTHERWISE TO SUBLICENSE, ASSIGN OR TRANSFER ANY OF THE RIGHTS, DUTIES OR OBLIGATIONS HEREUNDER IS VOID.

### **NO OTHER TERMS**

THE LICENSEE ACKNOWLEDGES THAT IT HAS READ THIS AGREEMENT, UNDERSTANDS IT AND AGREES TO BE BOUND BY ITS TERMS AND CONDITIONS. THE LICENSEE FURTHER AGREES THAT SUBJECT ONLY TO ANY EXPRESS WRITTEN TERMS OF AGREEMENT TO THE CONTRARY BETWEEN TAIT AND THE LICENSEE THIS IS THE COMPLETE AND EXCLUSIVE STATEMENT OF THE AGREEMENT BETWEEN IT AND TAIT IN RELATION TO THE SOFTWARE OR FIRMWARE WHICH SUPERSEDES ANY PROPOSAL OR PRIOR AGREEMENT, ORAL OR WRITTEN AND ANY OTHER COMMUNICATIONS BETWEEN THE LICENSEE AND TAIT RELATING TO THE SOFTWARE OR FIRMWARE.

# Index

## Numerics

3-way selector control 27

## A

alert tones 32

see also audible tones

antenna

safe distance from face 6

audible tones 32

changing volume of all 89

meaning of 94

turning off all 91

turning off radio control and

keypress tones 90

types of 32, 89

## B

background scan

changing group

membership 52

definition 51

backlighting

timer 86

turning on and off 86

turning on momentarily 87

battery

attaching to radio 20

charging 80

charging for first time

(‘priming’) 18

charging suspended 96

charging time 19, 81

cycles before reaches

maximum capacity 19

disposing of 84

extending shift life 88

fully discharging 83

indicator 28

low battery warning 80

maintaining performance

and life of 83

operating temperature

range 83

optimal charging conditions

80

optimal charging

temperature 96

recycling 84

removing from radio 78

storing 84

temperature range while

charging 80

troubleshooting 96

using after storing 84

belt clip

attaching to radio 20

removing 95

bypassing repeater 42

## C

call alert page 45

caller, identifying 41

calls

bypassing repeater 42

checking missed calls 43

identifying caller 41

making 36

permitted length of 36

priority call 71

receiving 41

to individual radio unit 40

to talkgroup 39

- channel
  - checking that clear (monitor) 44
  - home channel 50
  - removing from scan group 52
  - scanning 51
  - selecting 26, 38
  - voting 50

- channel selector control 26, 38, 48

- charger
  - LEDs on power up 79
  - power adaptor 96
  - removing radio from to receive call 82
  - troubleshooting 96
  - types available 79
  - using 81

- charging, optimal temperature range 96

- compliance information 5

## D

- deleting nuisance channels
  - from groups 52

- desktop charger 79

- digital radio
  - coverage 24
  - lack of static noise 24

- discharging batteries
  - how often 83

- dispatcher operation
  - radio check 46
  - radio inhibit 63
  - radio monitor 65
  - radio uninhibit 63
  - status request 60

- display
  - backlighting 86

- contrast 87
  - symbols 28
- distance, recommended safe from radio 6
- distress beacons, frequency band reserved for 8
- documentation, related 17
- down scroll key 29

## E

- emergency call
  - ending 74
  - types of 71
  - what happens during 72

- emergency mode
  - false powerdown 72
  - keep alive 72
  - phases of 72
  - radio is silent during 72
  - stealth and non-stealth modes 72
  - turning off 74
  - understanding 72

- encryption
  - changing keys 69
  - proper key detect 68
  - receiving an encrypted call 68
  - turning on and off 66
  - turning on and off using the 3-way selector 67

- encryption key
  - changing 69
  - preset 69
  - removing 70

- error messages 93

- exposure, to RF 5

**F**

- false powerdown
  - ending 74
  - explained 72
- firmware version, identifying 95
- frequency band, reserved for
  - distress beacons 8
- function key settings 27
- function keys 27

**G**

- green LED 34
- group
  - scanning groups 51
  - talkgroups 39
  - voting groups 50

**H**

- hardware version, identifying 95
- high temperature warning 93

**I**

- identifying caller 41
- indicator, low battery 80
- indicators, status LEDs 34
- indicators, volume of 89
- individual calls 40
- invalid keypress beep 33

**K**

- keep alive
  - explained 72
- key press
  - long and short, explained 25
- keypad
  - backlighting 86

- locking and unlocking 62
- keypress
  - invalid 33
  - tones. See audible tones.
  - valid 32

**L**

- LEDs, status 34
- left selection key 29
- lighting conditions
  - adjust display for 87
- locking the keypad 62
- lone worker feature 75
- long key press 25
- low battery warning 80
- low power transmissions
  - turning on and off 88

**M**

- Main menu
  - accessing 30
  - exiting quickly 30
- making calls 36
  - individual call 40
  - talkgroup call 39
  - see also Calls
- man down feature 76
- manuals, related 17
- menus
  - accessing 30
  - navigating 29
  - quick access 30, 31
- messages
  - pre-programmed 57
  - sending 57
- missed calls, checking 43
- monitor 44
  - radio display symbol for 28
  - turning on and off 44
- multi-charger 79



## N

- navigating menus 29
- NiCd (nickel cadmium) battery
  - using after storing 84
- non-stealth emergency
  - about 72
  - what happens during 72
- nuisance delete
  - scan groups 52
  - voting groups 50

## P

- paging a radio 45
- power consumption
  - reducing 88
- power up radio 26
- priming battery 18
- priority call, making 71
- priority channels, scanning 51

## Q

- quick access menus 30, 31
- quiet operation 90

## R

- radio
  - controls 25
  - not turning on 94
  - recommended safe distance
    - when using 6
  - turning on and off 26
  - version 95
  - when to switch off for safety
    - reasons 8
- radio check 46
- radio check feature 36
- radio controls, turning off
  - audible tones for 90

- radio display
  - error messages 93
- radio frequency (RF) energy
  - causing electronic devices to malfunction 8
  - compliance with exposure standards 6
  - controlling exposure to 5
- radio unit ID 36, 39, 41, 72
  - displaying when receive calls 41
- radio-monitor request 65
- reboot message 93
- recent calls 43
- recycling batteries 84
- red LED 34
- related documentation 17
- repeater talk around
  - radio display symbol for 28
- repeater talkaround 42
  - turning on and off 42
- revive 63
- RF, exposure to 5
- right selection key 29

## S

- safe distance, recommended
  - from radio 6
- safety
  - information 5
  - warnings used in user's guide 17
- scan groups 51
  - changing group
    - membership 52
  - removing nuisance channel
    - from 52
  - selecting 48
- scanning
  - a group of channels 51

- background scan 51
  - priority channels 51
  - radio display symbol for 28
  - standard scan 51
- scroll keys 29
- selection keys 29
- short key press 25
- signals, hearing faint and noisy 55
- silent operation 91
- speaker microphone, attaching 21
- speaker volume, adjusting 26
- squelch mute 55
- squelch override
  - turning on and off 55
- standard scan
  - definition 51
- status indicators
  - about 32
  - LEDs 34
- status LEDs 34
- status LEDs 32
- status query 60
- status update
  - requesting 60
- status updates
  - sending 59
- stealth emergency
  - about 72
  - what happens during 72
- storing batteries 84
- stun 63

## T

- talkaround. See repeater talkaround.
- talkgroup
  - making a call to 39
  - selecting 39

- talkgroups, explained 39
- talking directly to other radios 42
- Talking Party ID
  - turning on and off 41
- three-way selector control 27
- time-out timer 36
- transmission time, limited 36
- transmit timer 36
- transmitting, at low power 88
- troubleshooting 93

## U

- unlocking the keypad 62
- up scroll key 29

## V

- valid keypress beep 32
- version information, of radio 95
- volume, changing 26
- voting 50
- voting groups
  - removing channels from 50
  - selecting 48

## W

- warning tones. See audible tones
- warnings, on radio display 93

## Z

- zone selector control 27
- zones
  - about 37
  - selecting 37



[www.taitworld.com](http://www.taitworld.com)

08/06 MPA-00001-02

